

make sure door handles are unlocked before installing

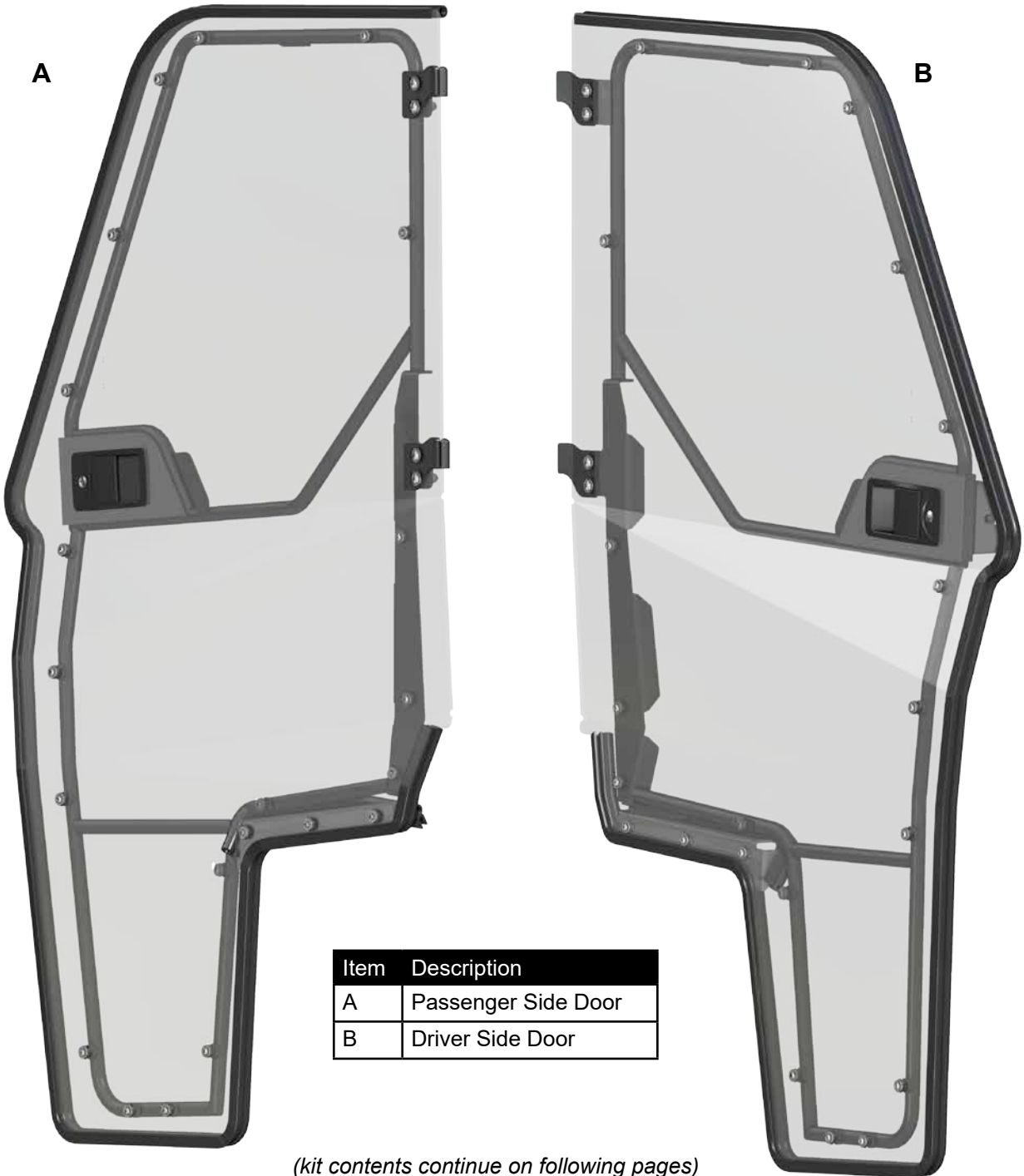

Item	Description
A	Passenger Side Door
B	Driver Side Door

(kit contents continue on following pages)

Need help with your installation?



sales@superatv.com



www.superatv.com



1-855-743-3427



8:00am - 8:00pm EST M-Th
 8:00am - 7:00pm EST Friday
 9:00am - 2:00pm EST Saturday

Read instructions and view illustrations before beginning.

Thank You

For Choosing



(kit contents continued)

Item	Description
C	Lower Support; passenger
D	Hinge Assembly; passenger
E	Striker x 2
F	Upper Support; passenger
G	Mount; passenger
H	Mount; driver
J	Lower Support; driver
K	Hinge Assembly; driver
L	Upper Support; driver
M	Strut x 2

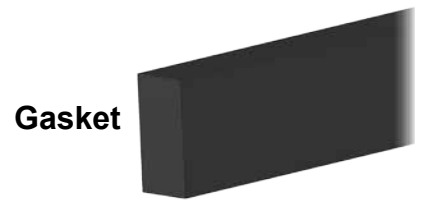
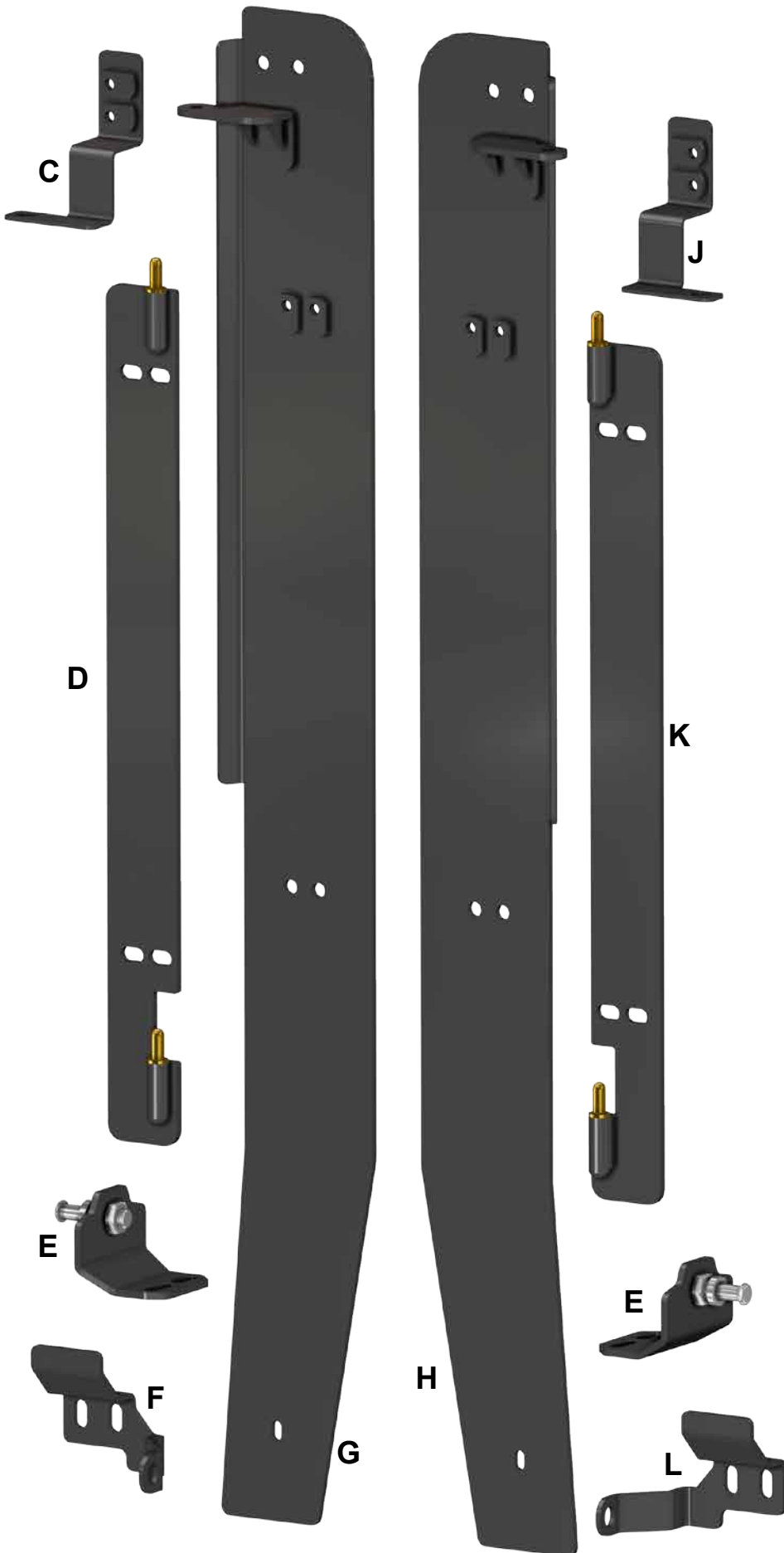

(kit contents continued)

4x  M5-.80 x 20mm Lg.

2x  M6-1.0 x 20mm Lg.

12x  M8-1.25 x 25mm Lg.

4x  M5-.80 Nylock Nut

2x  M6-1.0 Nylock Nut

8x  M8 Acorn Nut

8x  M8-1.25 Nylock Nut

2x  M6 Washer

12x  M8 Washer

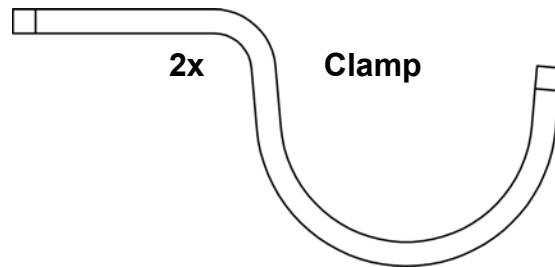

Door Cleaning:

- Do not use Rain-X®, Plexus® or any other protector, wax, or polish.
 - Do not use window cleaning fluids (Windex, 409, etc) or any solvents (gasoline, denatured alcohol, acetone, etc).
 - Never use abrasive cleaners, abrasive pads, or gritty cloths.
 - Never use razor blades, scrapers, squeegees, brushes, etc.
1. Thoroughly rinse Doors to float off dirt and mud.
 2. Using a soft cloth, or microfiber cloth, clean Doors with warm water and a gentle detergent. Baby shampoo, rubbing alcohol, or hand washing soap can also be used.
 3. To prevent water spots, use a chamois to blot Doors dry.

Liability Statement

SuperATV's® products are designed to best fit user's ATV/UTV under stock conditions. Adding, modifying, or fabricating any factory or aftermarket parts will void any warranty provided by SuperATV® and is not recommended. SuperATV's® products could interfere with other aftermarket accessories. If user has aftermarket products on machine, contact SuperATV® to verify that they will work together.

Although SuperATV® has thousands of satisfied customers, user should be aware that installing lift kits, long travel, or suspension kits, tires, etc. will change the ride of machine and may increase maintenance and part wear. Operating any off-road machine while, or after, consuming alcohol and/or drugs increases risk of bodily harm or death. No warranty or representation is made as to this product's ability to protect user from severe injury or death. SuperATV® urges operators and occupants to wear a helmet and appropriate riding gear at all times.

By purchasing and installing SuperATV® products, user agrees that should damages occur, SuperATV® will not be held responsible for loss of time, use, labor fees, replacement parts, or freight charges. SuperATV®, nor any 3rd party, will not be held responsible for any direct, indirect, incidental, special, or consequential damages that result from any product purchased from SuperATV®. The total liability of seller to user for all damages, losses, and causes of action, if any, shall not exceed the total purchase price paid for the product that gave rise to the claim.

SuperATV® will warranty only parts provided by SuperATV®. Any damage or problems with OEM housings, bearings, seals, or other manufacturers' products will not be covered by SuperATV®. SuperATV® parts and products are not warranted if item was not installed properly, misused, or modified.

Installing, adding, modifying, or fabricating any factory or aftermarket product to your ATV/UTV may violate certain local, state, and federal laws. Be advised that laws vary depending on town, city, county, state, etc. Use of certain products on public streets, roads, or highways may be in violation law. The Buyer is solely and exclusively legally and personally responsible for any violation of the law by the installation or use of the product. You must abide by all local, state, and federal laws, including but not limited to vehicle safety, traffic laws, and ordinances. It is your responsibility to know the laws and how they apply to you.

The Buyer is responsible to fully understand the capability and limitations of his/her vehicle according to manufacturer specifications, warnings and instructions and agrees to hold SuperATV® harmless from any damage resulting from failure to adhere to such specifications, warnings and/ or instructions. The Buyer is also responsible to obey all applicable federal, state, and local laws and ordinances when operating his/her vehicle while using this product, and the Buyer agrees to hold SuperATV® harmless from any violation thereof.

Raise Cargo Box before beginning.

- Remove Side Nets from both sides of machine.

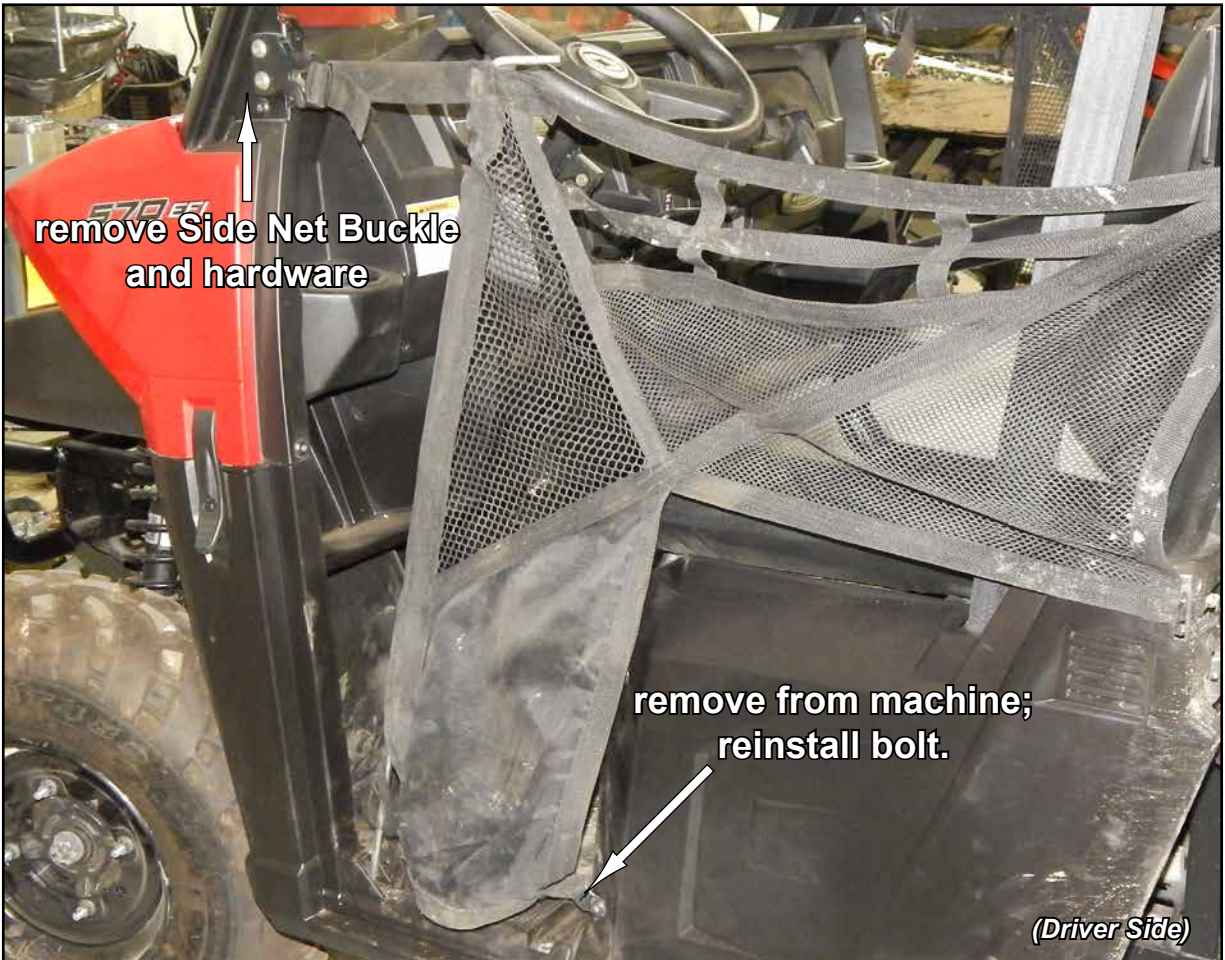

Driver Side installation shown



- Install Upper Support (L) and secure with stock Nut.



- Pull Seat Back forward and remove Nut shown.



- Install Lower Support (J) and secure with stock Nut.

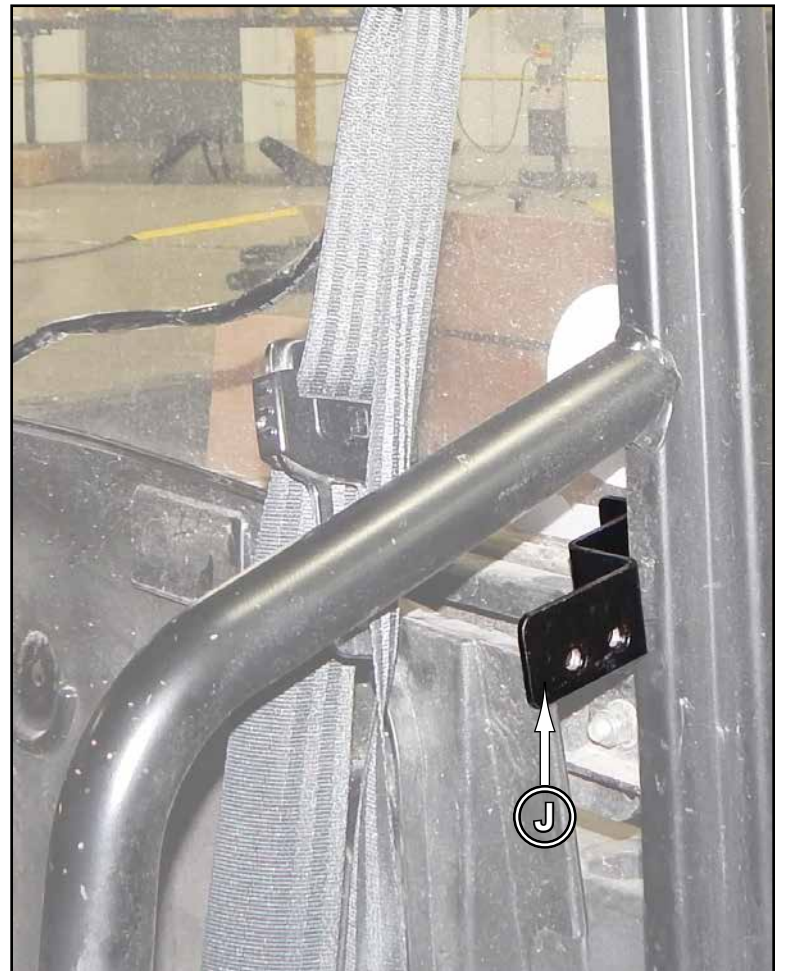
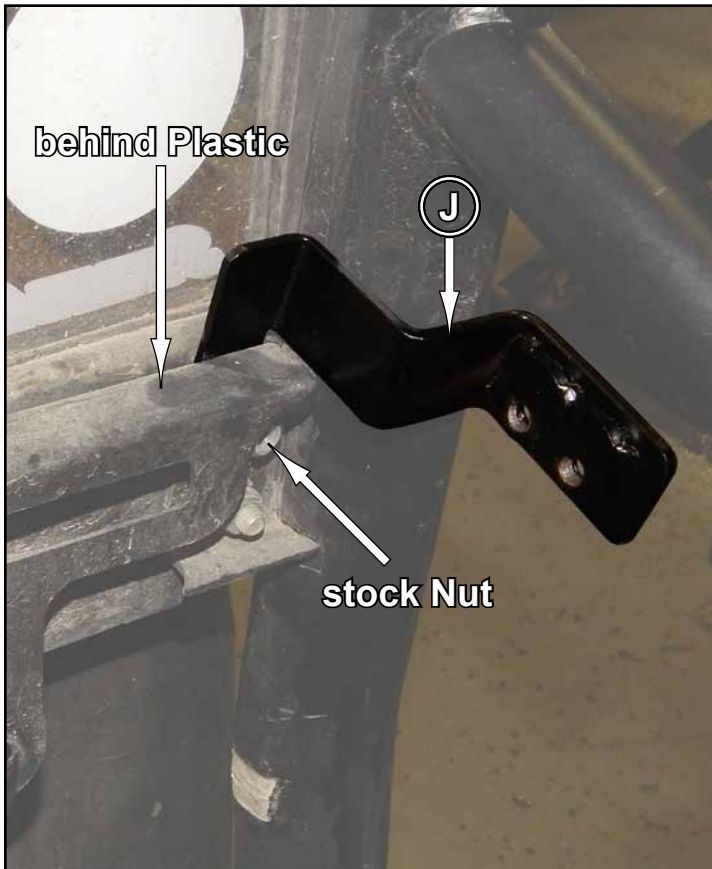

- Install Striker (E) with stock hardware.



- Install Mount (H) to Supports (L)(J) with hardware shown.
- Install Hinge Assembly (K) to Mount (H) with hardware shown.

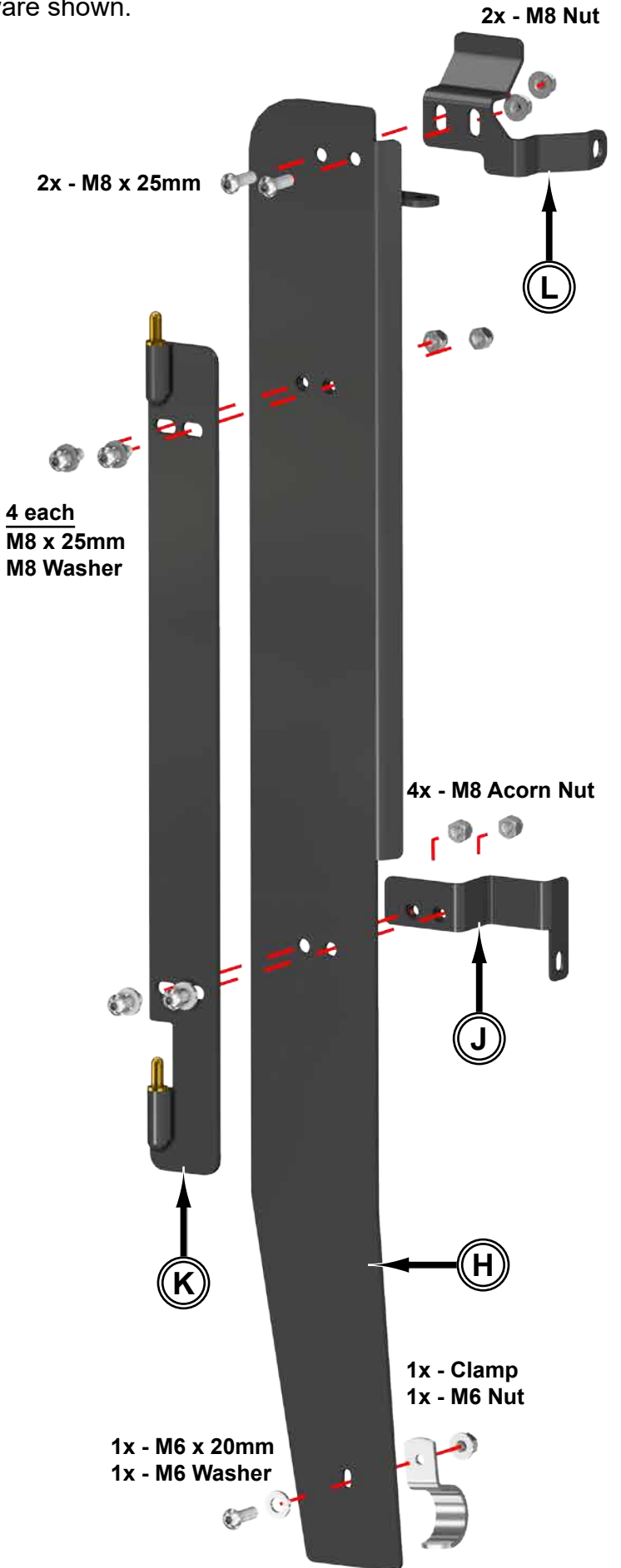
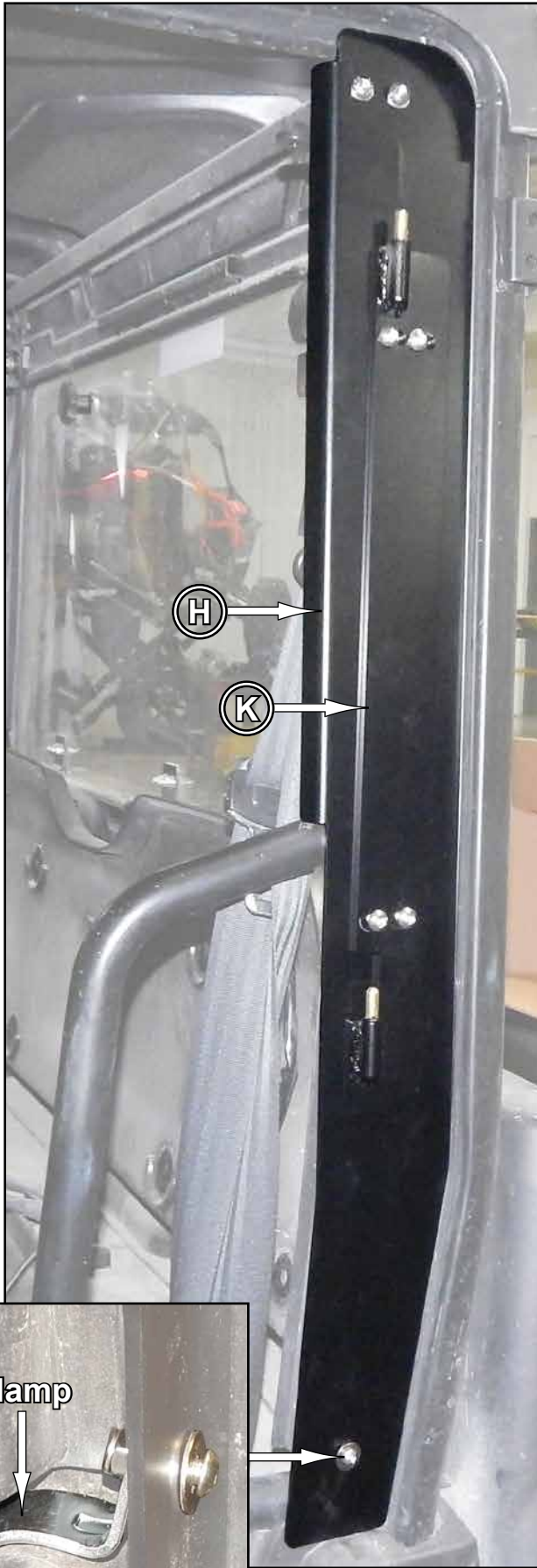

- Place Driver Side Door (B) onto Hinge Assembly; driver (K).



- Close Door and engage Latch.
- Align to machine and tighten all hardware completely.



- Install Strut (M) to Driver Side Door (B) and Upper Support; driver (L) with hardware shown.

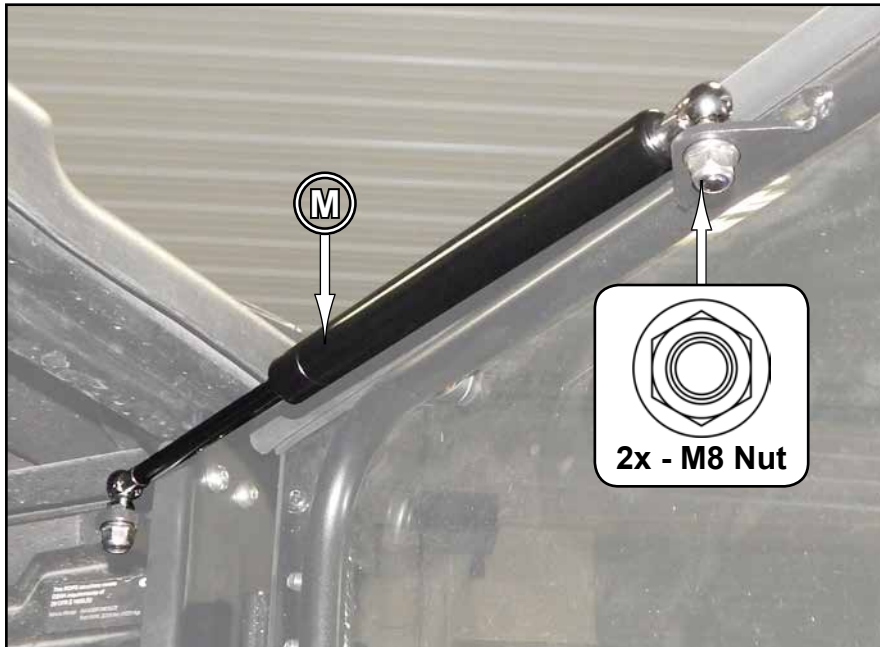

- Repeat steps for opposite side.

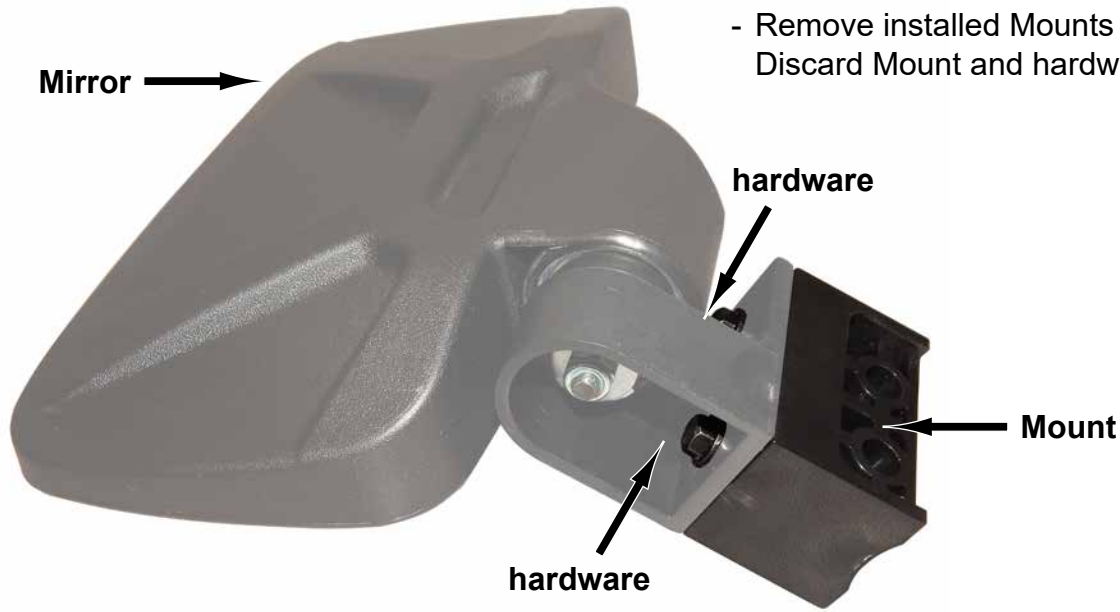

- Install Mirrors to Doors with hardware shown.

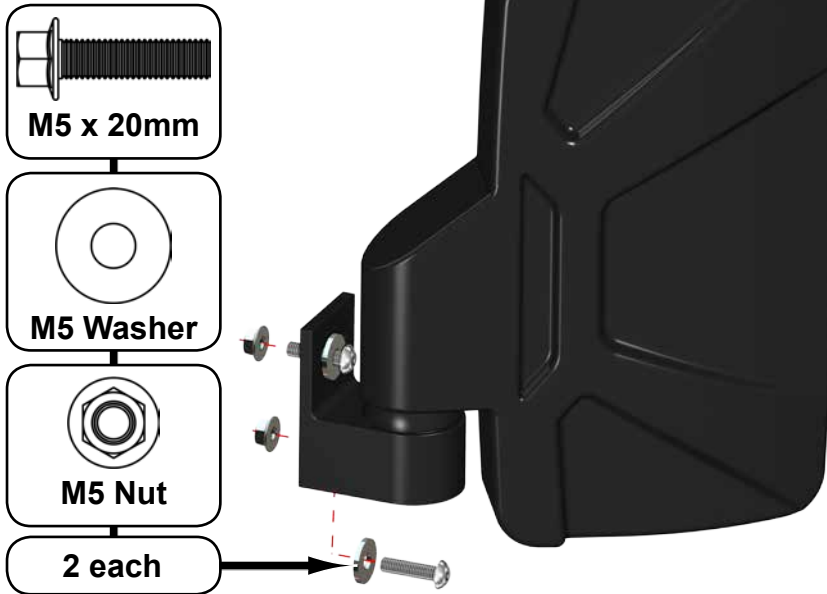

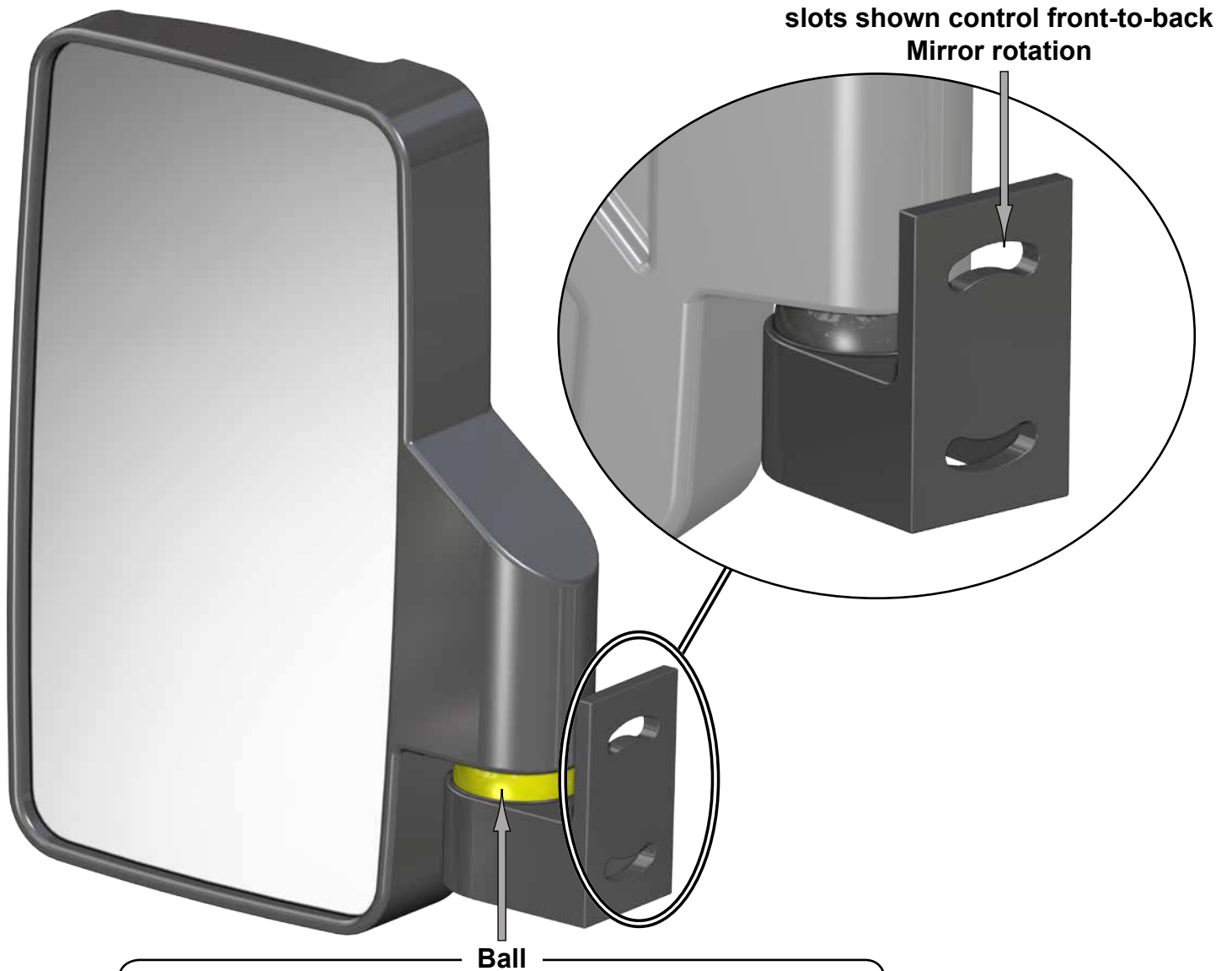

- Mirror is spring loaded and can also be adjusted here.
- Ball will allow adjustment in various directions.



