

Clutch Kit

Tire size, machine modifications, rider preferences, and machine usage are all factors to consider when tuning Clutch Kit. Specifics for every application are not within SuperATV's testing scope. By experimenting with different weight combinations, end user can achieve performance best suited for their riding needs and machine.

Liability Statement

SuperATV's® products are designed to best fit user's ATV/UTV under stock conditions. Adding, modifying, or fabricating any factory or aftermarket parts will void any warranty provided by SuperATV® and is not recommended. SuperATV's® products could interfere with other aftermarket accessories. If user has aftermarket products on machine, contact SuperATV® to verify that they will work together.

Although SuperATV® has thousands of satisfied customers, user should be aware that installing lift kits, long travel, or suspension kits, tires, etc. will change the ride of machine and may increase maintenance and part wear. Operating any off-road machine while, or after, consuming alcohol and/or drugs increases risk of bodily harm or death. No warranty or representation is made as to this product's ability to protect user from severe injury or death. SuperATV® urges operators and occupants to wear a helmet and appropriate riding gear at all times.

By purchasing and installing SuperATV® products, user agrees that should damages occur, SuperATV® will not be held responsible for loss of time, use, labor fees, replacement parts, or freight charges. SuperATV®, nor any 3rd party, will not be held responsible for any direct, indirect, incidental, special, or consequential damages that result from any product purchased from SuperATV®. The total liability of seller to user for all damages, losses, and causes of action, if any, shall not exceed the total purchase price paid for the product that gave rise to the claim.

SuperATV® will warranty only parts provided by SuperATV®. Any damage or problems with OEM housings, bearings, seals, or other manufacturers' products will not be covered by SuperATV®. SuperATV® parts and products are not warrantied if item was not installed properly, misused, or modified.

Installing, adding, modifying, or fabricating any factory or aftermarket product to your ATV/UTV may violate certain local, state, and federal laws. Be advised that laws vary depending on town, city, county, state, etc. Use of certain products on public streets, roads, or highways may be in violation law. The Buyer is solely and exclusively legally and personally responsible for any violation of the law by the installation or use of the product. You must abide by all local, state, and federal laws, including but not limited to vehicle safety, traffic laws, and ordinances. It is your responsibility to know the laws and how they apply to you.

The Buyer is responsible to fully understand the capability and limitations of his/her vehicle according to manufacturer specifications, warnings and instructions and agrees to hold SuperATV® harmless from any damage resulting from failure to adhere to such specifications, warnings and/ or instructions. The Buyer is also responsible to obey all applicable federal, state, and local laws and ordinances when operating his/her vehicle while using this product, and the Buyer agrees to hold SuperATV® harmless from any violation thereof.

Need help with your installation?



sales@superatv.com



www.superatv.com



1-855-743-3427



8:00am - 9:00pm EST M-Th
8:00am - 7:00pm EST Friday
9:00am - 2:00pm EST Saturday

Read instructions and view illustrations before beginning.

Thank You

For Choosing

SUPERATV.COM[®]



Springs and Clutch Arms shown are for representation only:

- Kits are machine specific. Springs will be a different color and Clutch Arms will contain different combinations of weights.
- Not all Secondary (Driven) Clutches use a removable Helix; not all kits will include a new Helix.

Secondary Spring

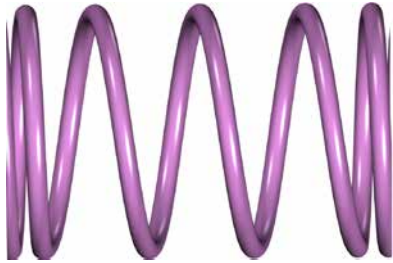

Primary Spring

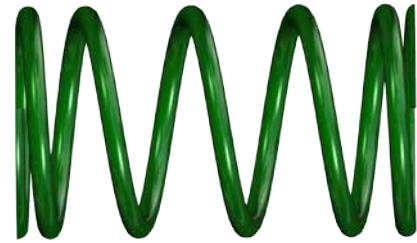

Helix

**straight notch is no
engine braking**

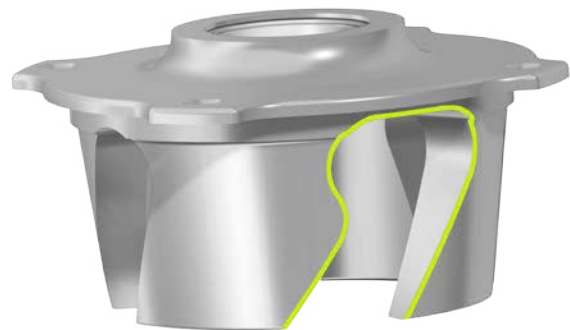

**notch with dog leg gives
engine braking**

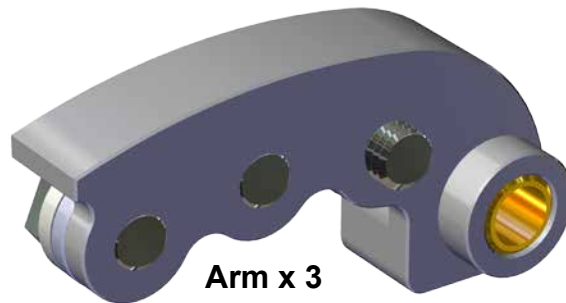

Arm x 3

Primary Clutch Spring: *keep all components removed from Clutch.*

SuperATV recommends using a clutch press tool when removing and reinstalling Cover Plate.



To keep Clutch balance, mark Cover Plate and Spider if "X" marking is not present.

Install new Primary Clutch Spring and Clutch Arms.

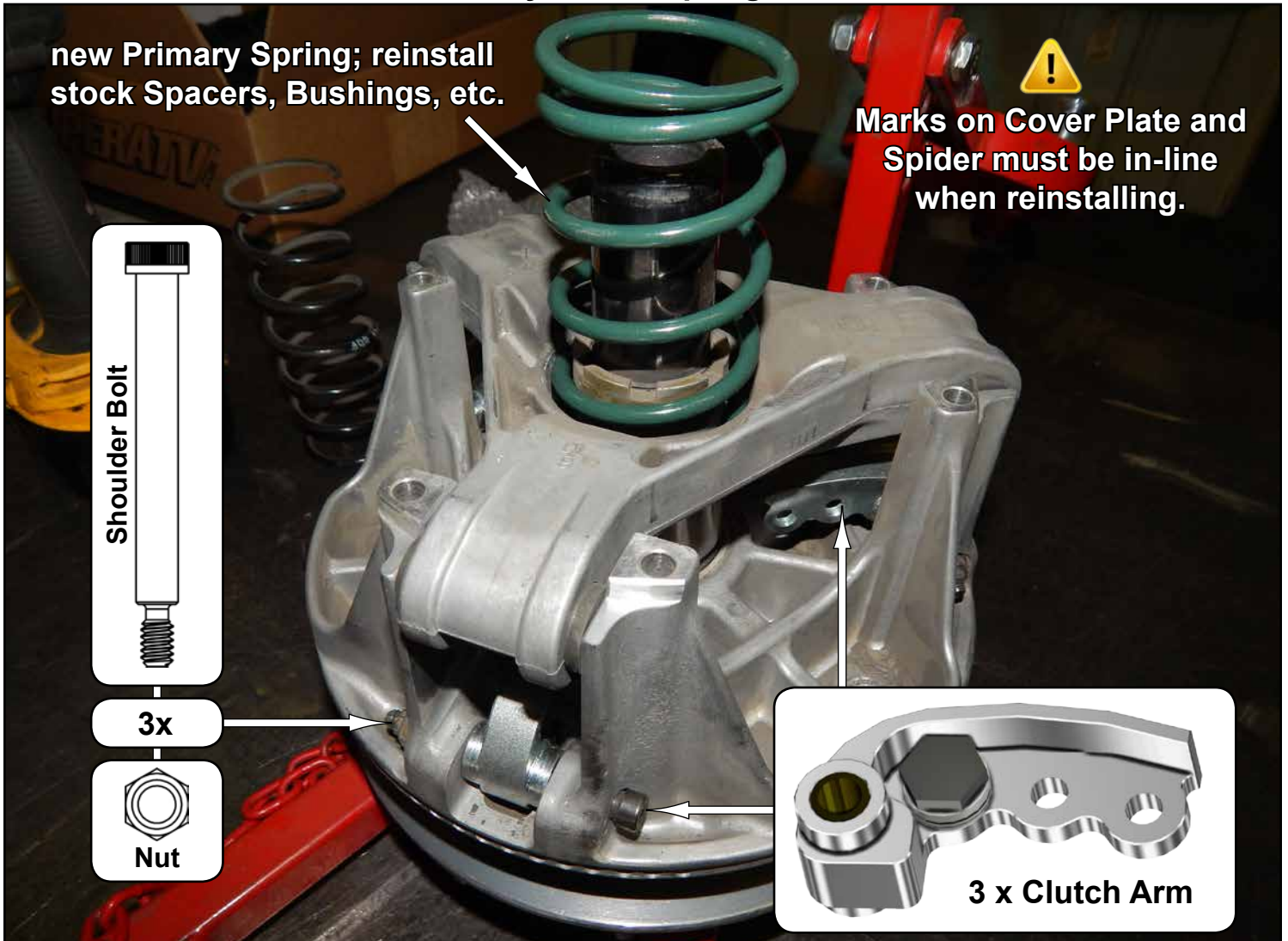

Torque hardware to manufacturers specs.

More Heel Weight: lowers engagement RPM and machine will pull stronger on take off (big tires).
 More Tip Weight: lowers shift RPM but will make upshifts harder. Shift point RPM is also lower.

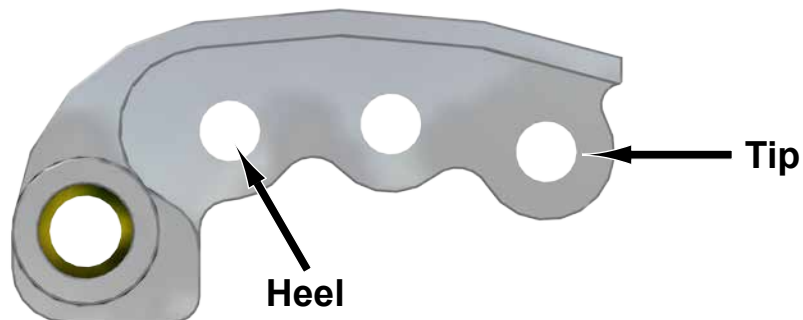

Engagement RPM: RPM at which Drive (Primary) Clutch begins squeezing side of Belt.

Shift Point RPM: RPM reached at WOT (Wide Open Throttle) until Clutches have finished moving (shifting). At WOT, RPM's will climb to, and remain, until Clutches are done shifting.

* Clutches are done shifting near, but not quite, at top speed of machine.

* When Clutches finish shifting, engine will continue to climb a few hundred RPM's until Rev or Speed Limiter is reached, or engine has no more power to advance RPM's.

Secondary (Driven) Clutch Spring and Helix: keep all components removed.







mark location in area shown

To keep Clutch balance, mark components as shown.



mark location in area shown

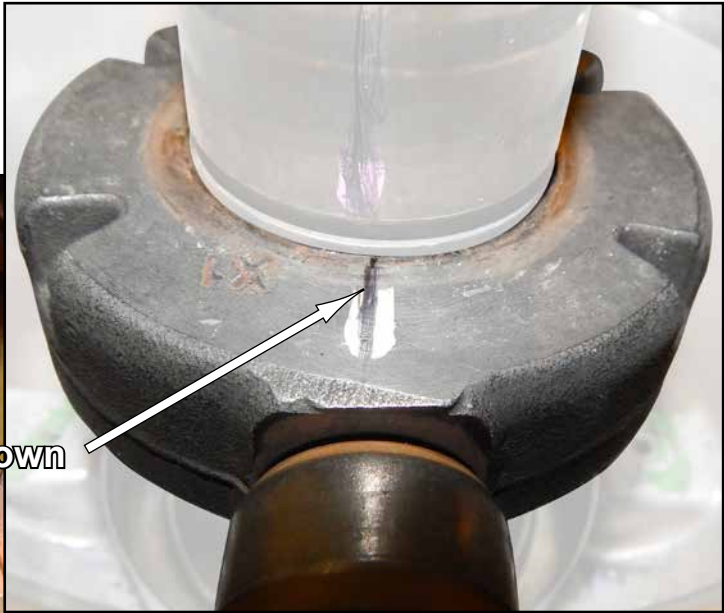

Install new Secondary (Driven) Clutch Spring



- Reinstall previously removed components.
- Use Compression Tool and resecure Retaining Ring.







- Install new Helix with stock hardware.
- *Torque hardware to manufacturers specs.*

new Helix

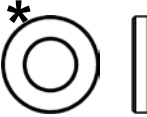
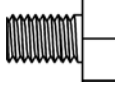
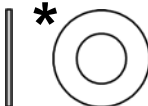
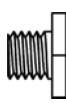
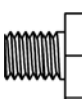

- Reverse steps taken during removal and reinstall Primary and Secondary (Driven) Clutch to machine. **Torque all hardware to manufacturers specs.**
- Test drive machine and note how machine performs with new Clutch Kit.
- If initial setup is not ideal for your riding needs, try a different combination of Weights.

OPTIONAL, not included with Clutch Kit, Adjustable Weight Box

 CKA-001-0.8GF	 CKA-001-2.0GF	 Vibra-TITE® Threadlocker	 CKA-001-3.0GW	 CKA-001-5.8GF
 CKA-001-0.5GW	 CKA-001-2.5GF	empty	 CKA-001-3.5GF	 CKA-001-1.5GW

*** Washers are located below foam. Use foam to keep Washers in place.**

When installing any weight to Clutch Arms, Vibra-TITE® Threadlocker must be used.