

**INSTALLATION INSTRUCTIONS**

**SPM-P-XPD: Snow Plow Mount**

- Ⓢ Please look through and read these instructions BEFORE starting so you understand what processes you'll be doing, and possible extra tools you may need.
- Ⓢ Do Not discard product packaging until installation is complete and functioning properly.

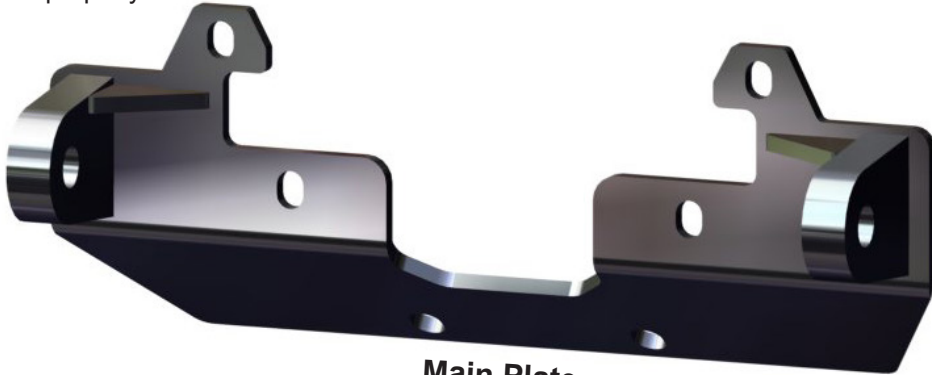

**Main Plate**



**Frame Mounts**



**Spacer Plate**

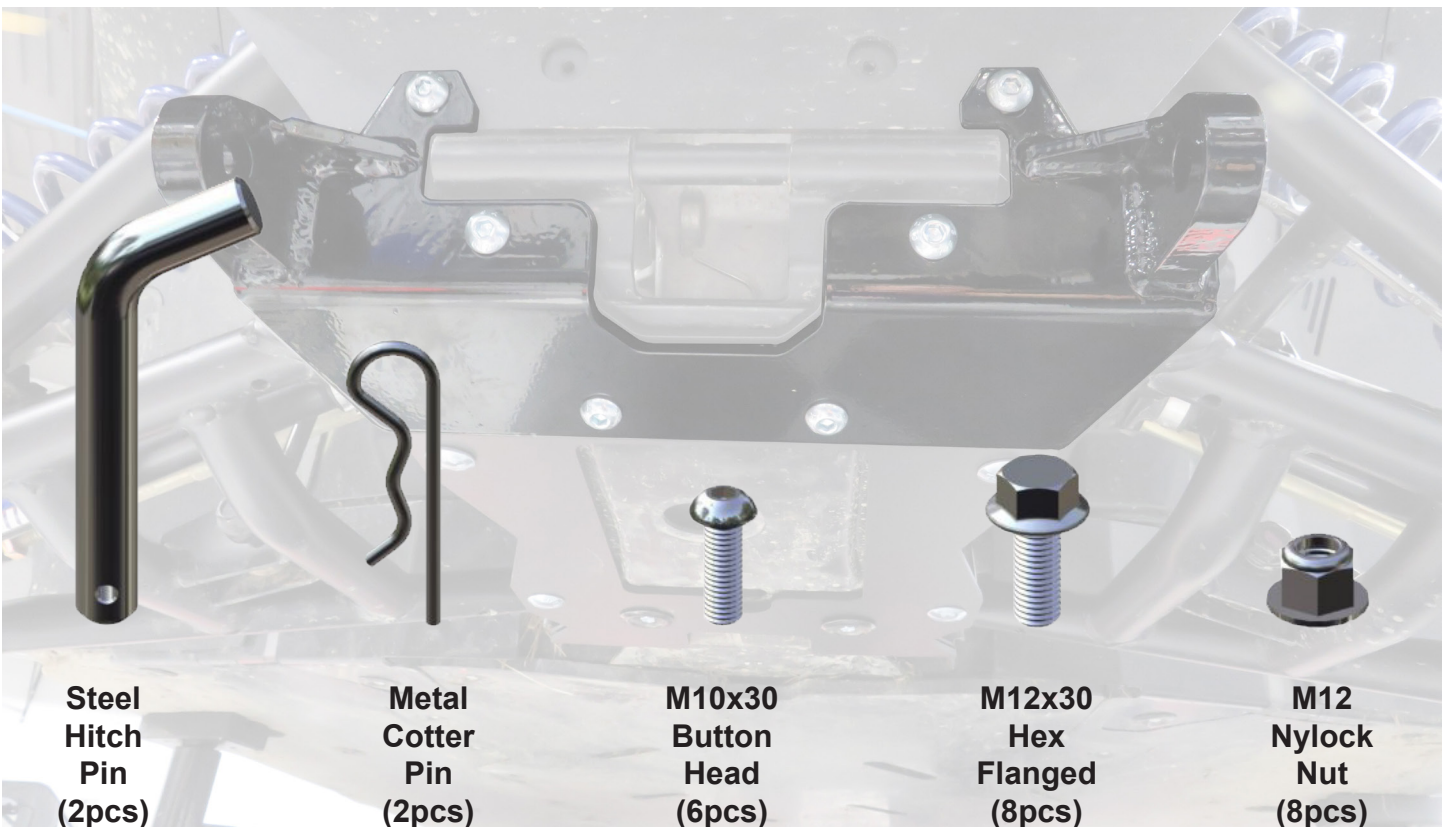

**Steel Hitch Pin (2pcs)**

**Metal Cotter Pin (2pcs)**

**M10x30 Button Head (6pcs)**

**M12x30 Hex Flanged (8pcs)**

**M12 Nylock Nut (8pcs)**

1. The first thing you need to do is **Remove the Four (4) Bolts** from the front of the machine as shown in Fig.1a-b.

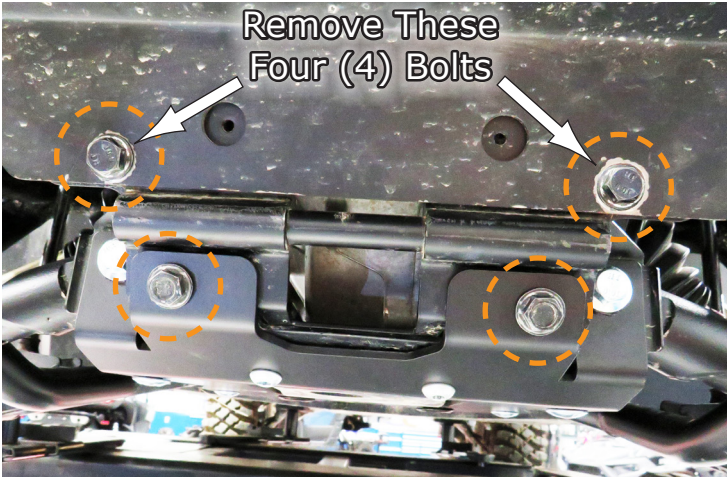

Fig.1a

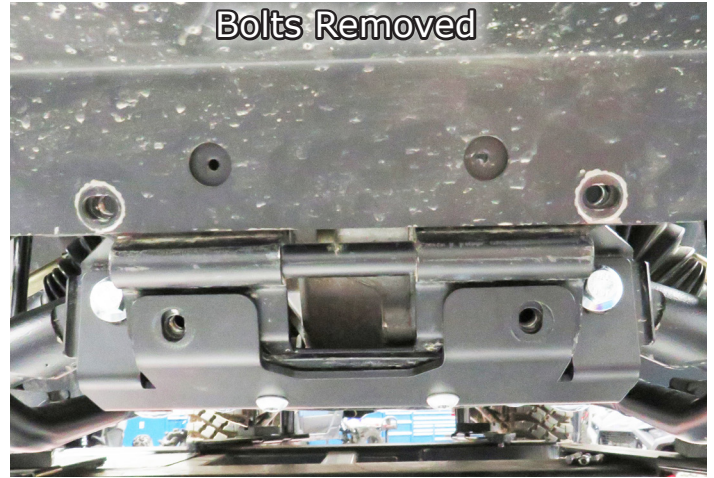

Fig.1b



2. Next, there is a **Spacer Plate** provided in your kit for you to use only if you **DO NOT** have a Frame Stiffener installed, shown in Fig.2. The Frame Stiffener is the tinted blue item. The Spacer is used in place of a frame stiffener so the mount has the same spacing behind it. You can see the hole patterns are the same and will install in the same manner. So if you have a frame stiffener, you will **NOT** use this part. See Fig.2.

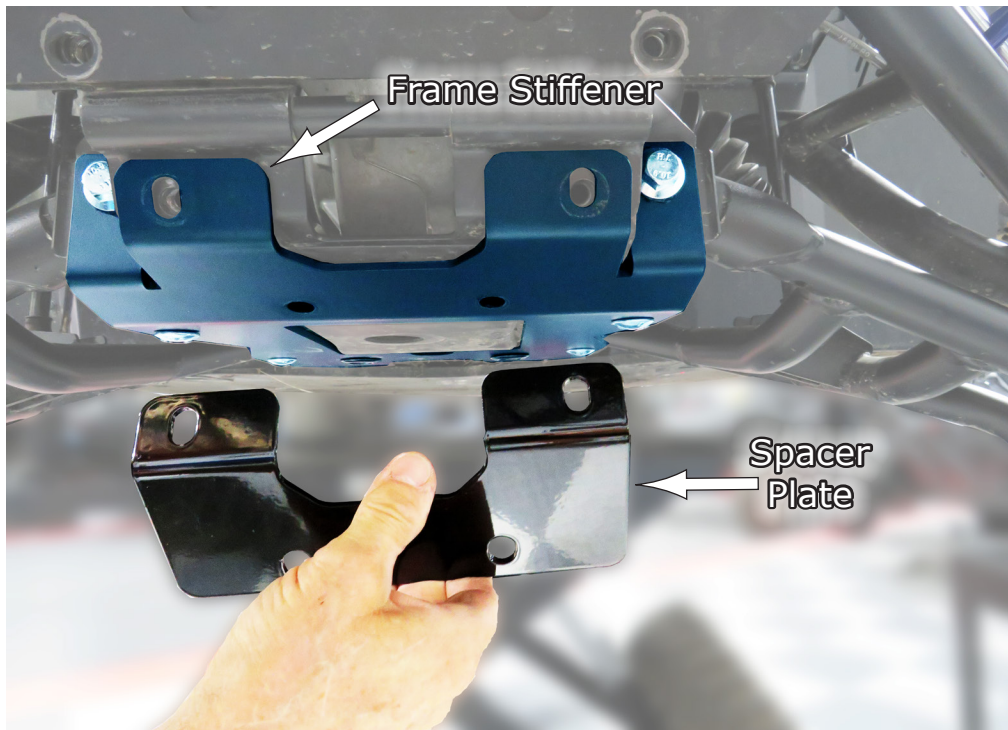
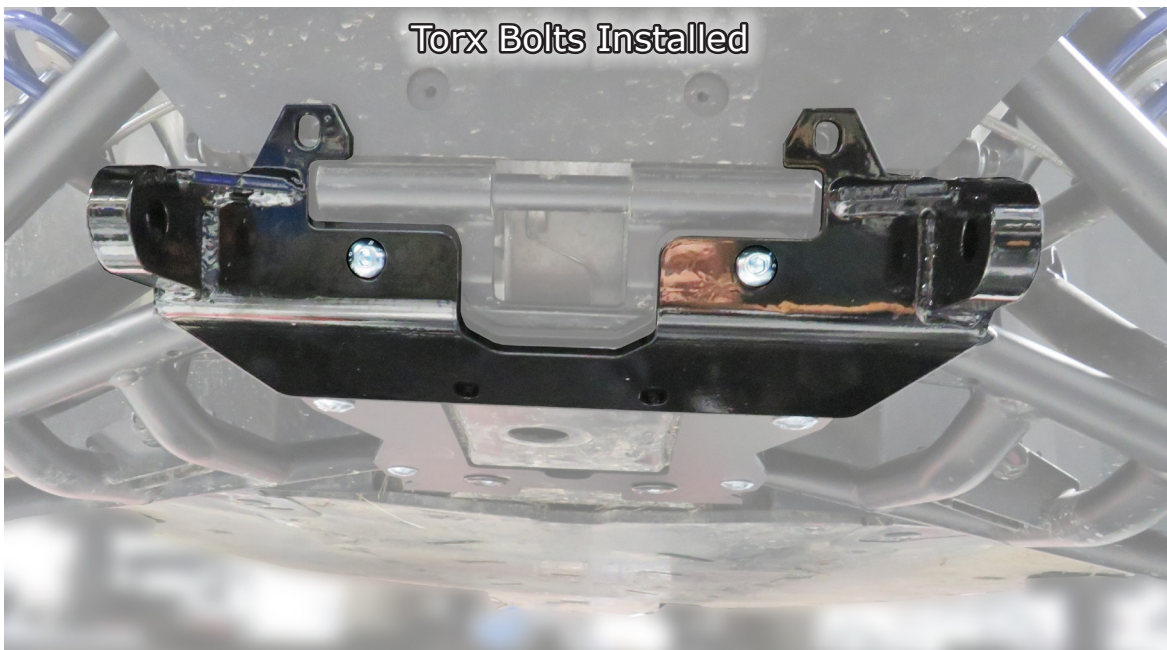

Fig.2

3. Now you can **Mount the Main Plate** to the snow plow mount. (**NOTE: At this point, if you do not have a frame stiffener, you will insert the Spacer behind the Main Plate and mount them both together with the Main Plate in front, and install the bolts accordingly**) Then **Install the Torx Bolts** you removed previously in the front two places as shown in **Fig.3a-b**. Do not tighten down yet until all the other bolts are threaded in.



**Fig.3a**



**Fig.3b**

4. Now Install the **Lower Bolts** as shown in Fig.4a-b.

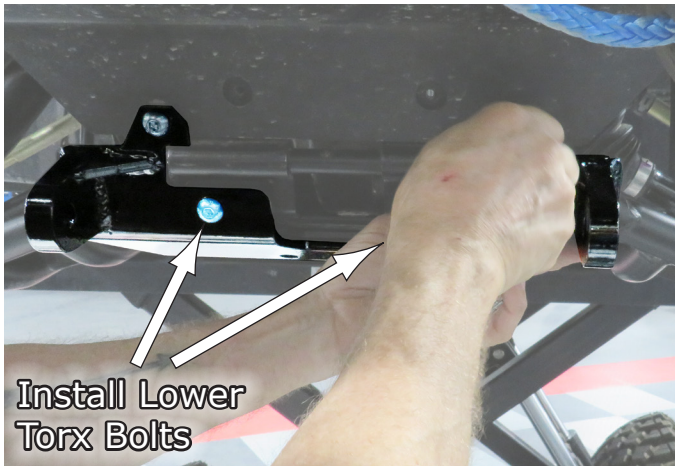

Fig.4a

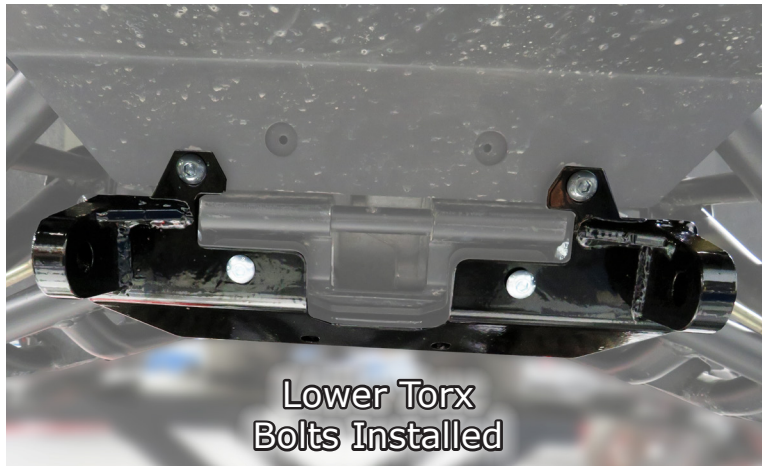

Fig.4b

5. Then Install the **Bottom Side Bolts** on the underside as shown in Fig.5a-b.



Fig.5a

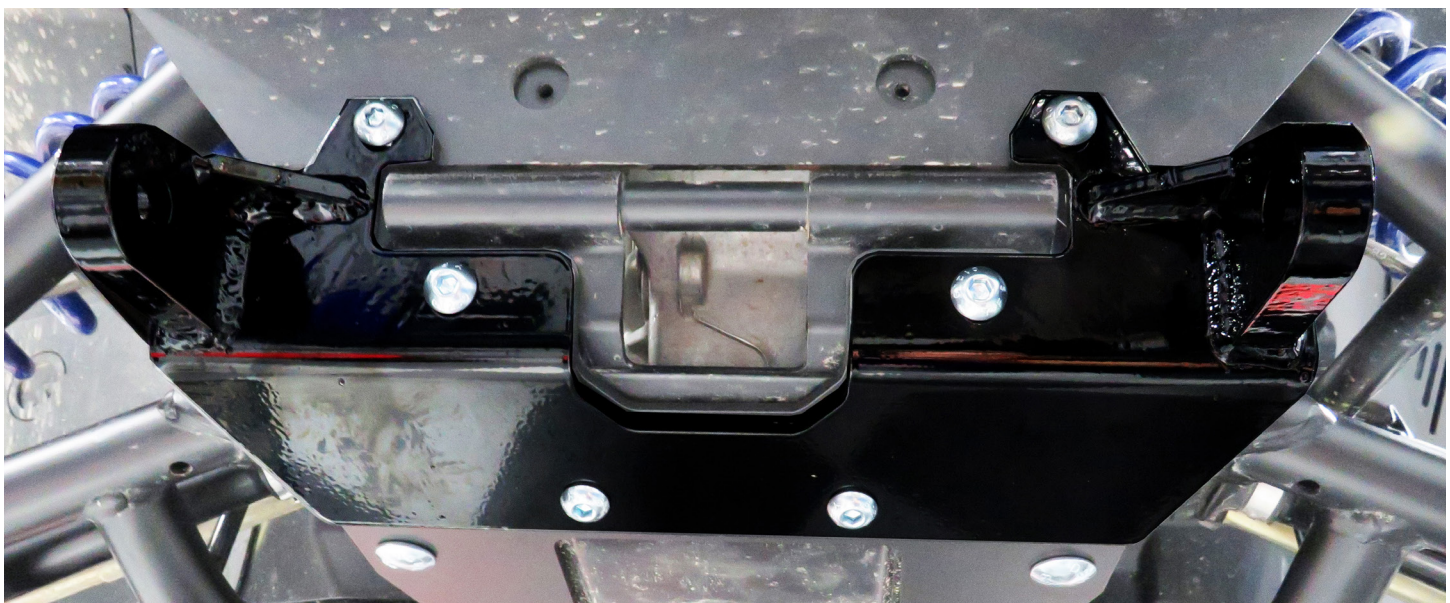

Fig.5b

6. Now go back and tighten all bolts secure.



#### Liability Statement

SuperATV's® products are designed to best fit user's ATV/UTV under stock conditions. Adding, modifying, or fabricating any factory or aftermarket parts will void any warranty provided by SuperATV® and is not recommended. SuperATV's® products could interfere with other aftermarket accessories. If user has aftermarket products on machine, contact SuperATV® to verify that they will work together.

Although SuperATV® has thousands of satisfied customers, user should be aware that installing lift kits, long travel, or suspension kits, tires, etc. will change the ride of machine and may increase maintenance and part wear. Operating any off-road machine while, or after, consuming alcohol and/or drugs increases risk of bodily harm or death. No warranty or representation is made as to this product's ability to protect user from severe injury or death. SuperATV® urges operators and occupants to wear a helmet and appropriate riding gear at all times.

By purchasing and installing SuperATV® products, user agrees that should damages occur, SuperATV® will not be held responsible for loss of time, use, labor fees, replacement parts, or freight charges. SuperATV®, nor any 3rd party, will not be held responsible for any direct, indirect, incidental, special, or consequential damages that result from any product purchased from SuperATV®. The total liability of seller to user for all damages, losses, and causes of action, if any, shall not exceed the total purchase price paid for the product that gave rise to the claim.

SuperATV® will warranty only parts provided by SuperATV®. Any damage or problems with OEM housings, bearings, seals, or other manufacturers' products will not be covered by SuperATV®. SuperATV® parts and products are not warranted if item was not installed properly, misused, or modified.

Installing, adding, modifying, or fabricating any factory or aftermarket product to your ATV/UTV may violate certain local, state, and federal laws. Be advised that laws vary depending on town, city, county, state, etc. Use of certain products on public streets, roads, or highways may be in violation law. The Buyer is solely and exclusively legally and personally responsible for any violation of the law by the installation or use of the product. You must abide by all local, state, and federal laws, including but not limited to vehicle safety, traffic laws, and ordinances. It is your responsibility to know the laws and how they apply to you.

The Buyer is responsible to fully understand the capability and limitations of his/her vehicle according to manufacturer specifications, warnings and instructions and agrees to hold SuperATV® harmless from any damage resulting from failure to adhere to such specifications, warnings and/ or instructions. The Buyer is also responsible to obey all applicable federal, state, and local laws and ordinances when operating his/her vehicle while using this product, and the Buyer agrees to hold SuperATV® harmless from any violation thereof.

If you have any problems/questions on this kit, contact us by email at [superatv.com](mailto:sales@superatv.com).

#### Need help with your installation?



[sales@superatv.com](mailto:sales@superatv.com)



[www.superatv.com](http://www.superatv.com)



1-855-743-3427



8:00am - 9:00pm EST M-Th  
8:00am - 7:00pm EST Friday  
9:00am - 2:00pm EST Saturday

*Thank You  
For Choosing*



**Like SuperATV on Facebook to keep up to date on new products!**