

INSTALLATION INSTRUCTIONS
Winch Mount: for Polaris RZR XP[®] Turbo S

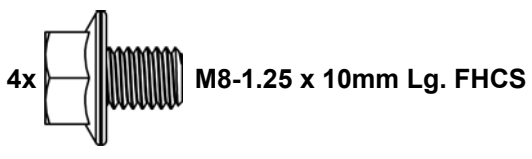
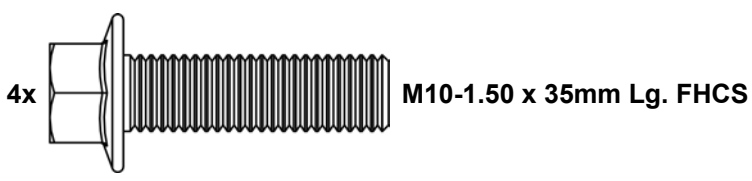
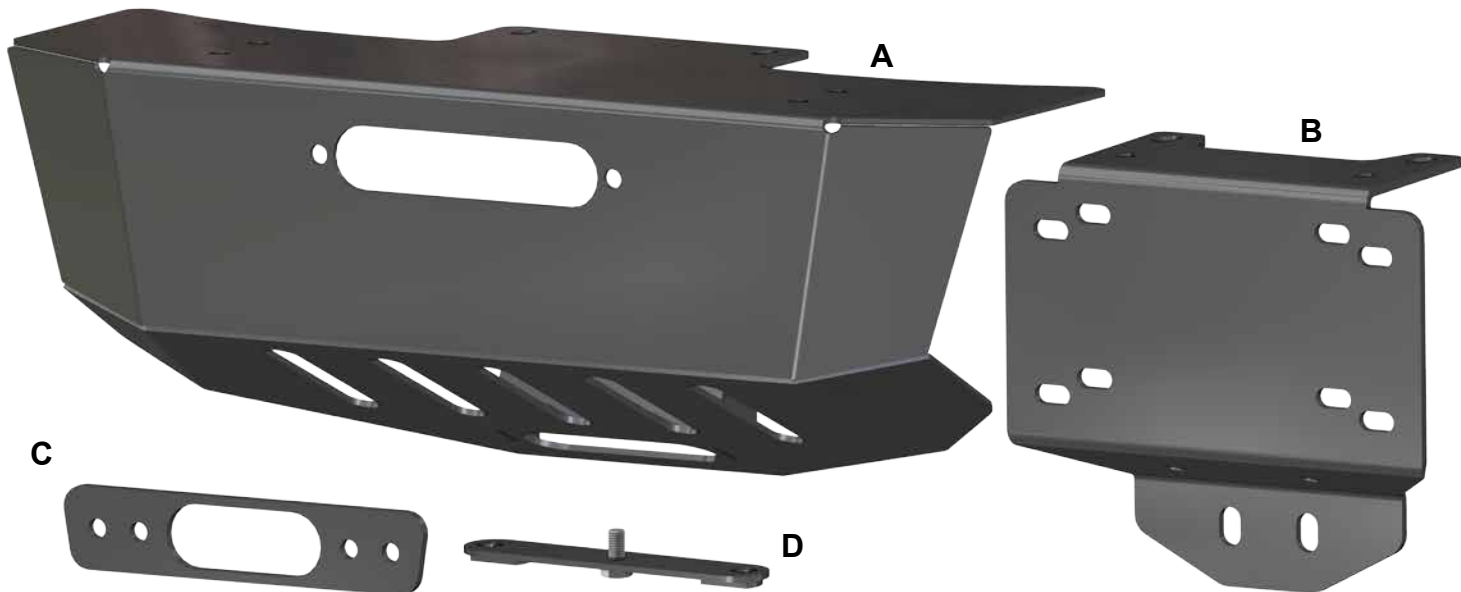

Item	Description
A	Cover
B	Mount
C	Fairlead Adapter
D	Backing Plate

discard any remaining hardware

Need help with your installation?

✉ sales@superatv.com 🖥 www.superatv.com

☎ 1-855-743-3427 🕒 8:00am - 9:00pm EST M-Th
 8:00am - 7:00pm EST Friday
 9:00am - 2:00pm EST Saturday

Read instructions and view illustrations before beginning.

*Thank You
 For Choosing*
SUPERATV.COM[®]





- Install Backing Plate (D) to Frame with hardware shown.

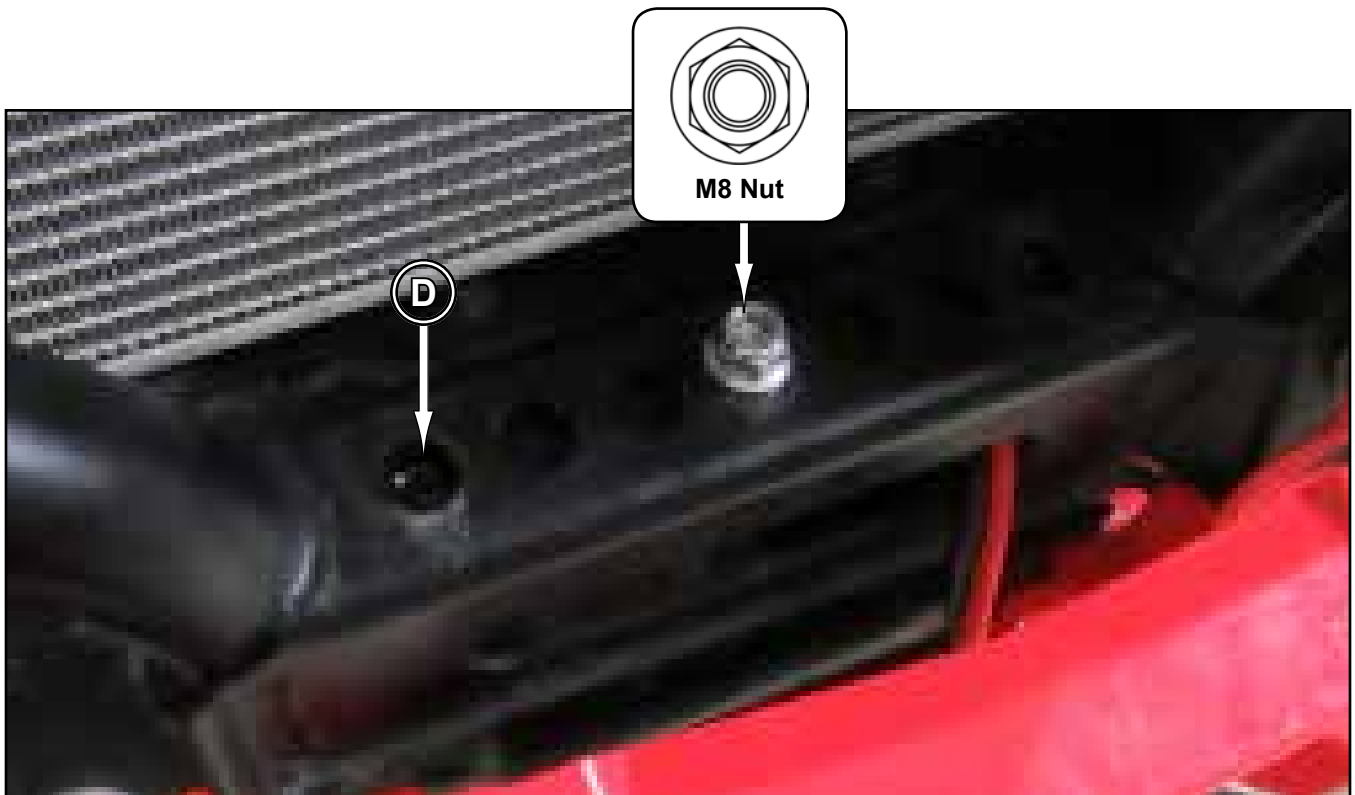

- Install Winch to Mount (B). Hardware included with Winch; tighten completely.



- Install Mount (B) to Backing Plate (D) with hardware shown.

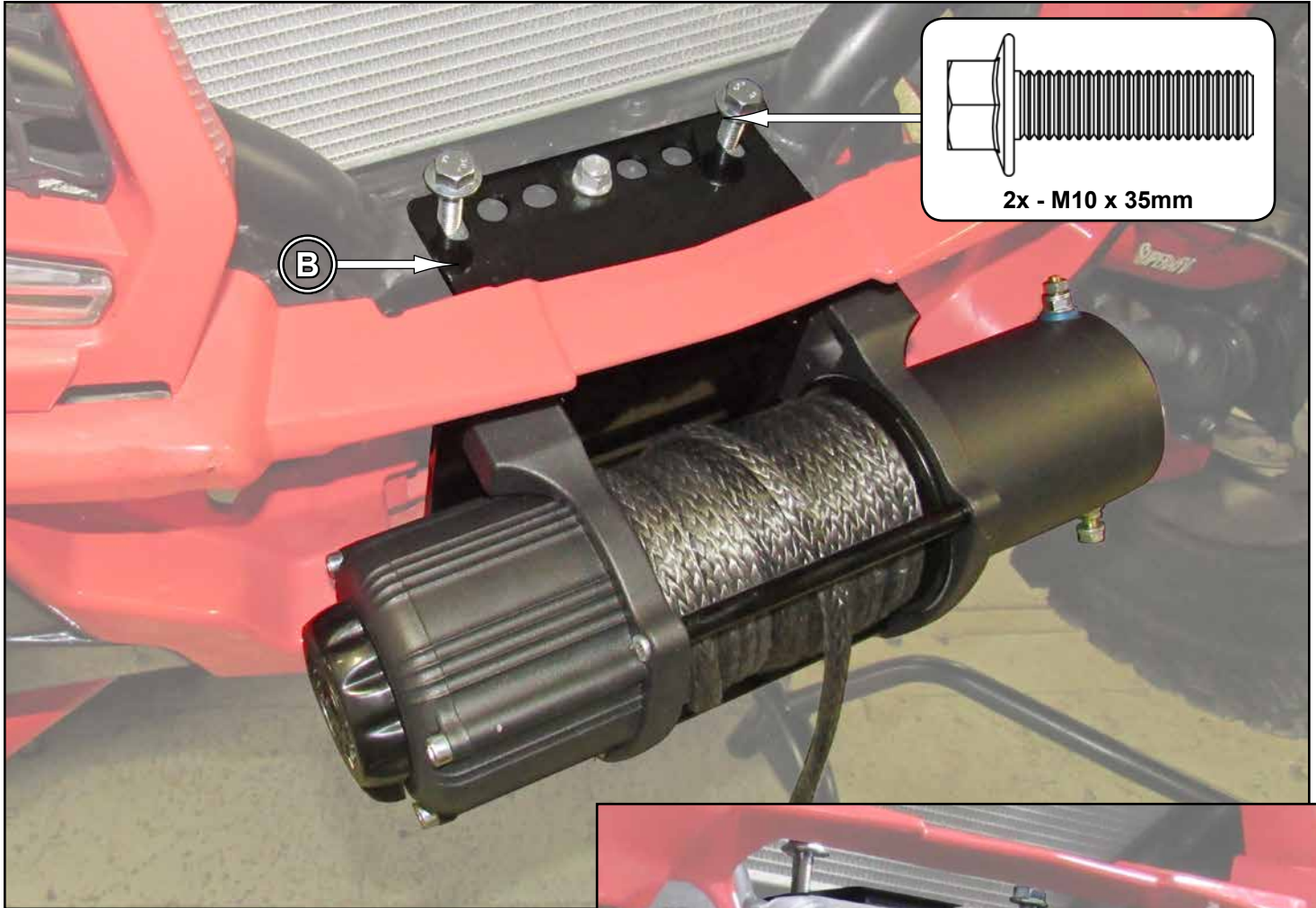

- Secure Mount (B) to Tow Hook Backer with hardware shown.



- Tighten hardware completely.

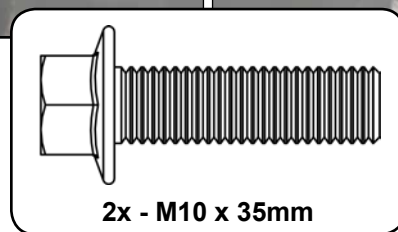

- Install Fairlead to Cover (A). Fairlead and hardware included with Winch; tighten completely.

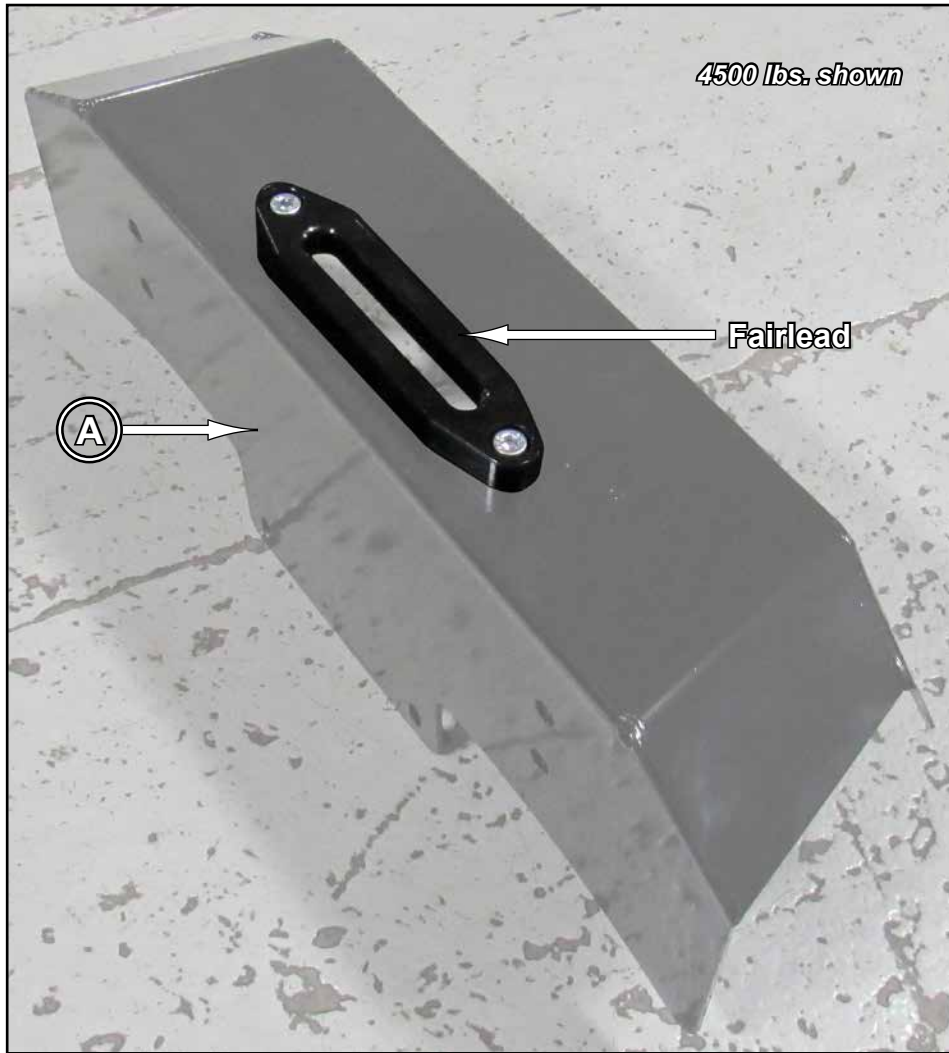

3500 lbs. Winch Fairlead install:

- Install Fairlead Adapter (C) to Cover (A) with provided M8 hardware; tighten completely.
- Install Fairlead to Fairlead Adapter (C). Fairlead and hardware included with Winch; tighten completely.



- Install Cover (A) to Mount (B) with hardware shown.

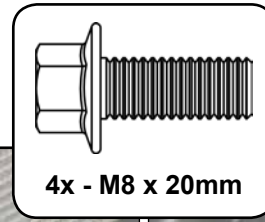

- Tighten hardware completely.

- Install stock Bumper to Cover (A) with hardware shown.



Liability Statement

SuperATV's® products are designed to best fit user's ATV/UTV under stock conditions. Adding, modifying, or fabricating any factory or aftermarket parts will void any warranty provided by SuperATV® and is not recommended. SuperATV's® products could interfere with other aftermarket accessories. If user has aftermarket products on machine, contact SuperATV® to verify that they will work together.

Although SuperATV® has thousands of satisfied customers, user should be aware that installing lift kits, long travel, or suspension kits, tires, etc. will change the ride of machine and may increase maintenance and part wear. Operating any off-road machine while, or after, consuming alcohol and/or drugs increases risk of bodily harm or death. No warranty or representation is made as to this product's ability to protect user from severe injury or death. SuperATV® urges operators and occupants to wear a helmet and appropriate riding gear at all times.

By purchasing and installing SuperATV® products, user agrees that should damages occur, SuperATV® will not be held responsible for loss of time, use, labor fees, replacement parts, or freight charges. SuperATV®, nor any 3rd party, will not be held responsible for any direct, indirect, incidental, special, or consequential damages that result from any product purchased from SuperATV®. The total liability of seller to user for all damages, losses, and causes of action, if any, shall not exceed the total purchase price paid for the product that gave rise to the claim.

SuperATV® will warranty only parts provided by SuperATV®. Any damage or problems with OEM housings, bearings, seals, or other manufacturers' products will not be covered by SuperATV®. SuperATV® parts and products are not warranted if item was not installed properly, misused, or modified.

Installing, adding, modifying, or fabricating any factory or aftermarket product to your ATV/UTV may violate certain local, state, and federal laws. Be advised that laws vary depending on town, city, county, state, etc. Use of certain products on public streets, roads, or highways may be in violation law. The Buyer is solely and exclusively legally and personally responsible for any violation of the law by the installation or use of the product. You must abide by all local, state, and federal laws, including but not limited to vehicle safety, traffic laws, and ordinances. It is your responsibility to know the laws and how they apply to you.

The Buyer is responsible to fully understand the capability and limitations of his/her vehicle according to manufacturer specifications, warnings and instructions and agrees to hold SuperATV® harmless from any damage resulting from failure to adhere to such specifications, warnings and/ or instructions. The Buyer is also responsible to obey all applicable federal, state, and local laws and ordinances when operating his/her vehicle while using this product, and the Buyer agrees to hold SuperATV® harmless from any violation thereof.



WN-2500 / WN-3500 / WN-4500 / WN-6000 Winch guide



Stopper



Clevis Pin and Hook



Fairlead



Rocker Mount



Dash Mount Switch

(WN-4500 and WN-6000 only)



Mounting Plate



Winch (WN-6000 shown)



Solenoid



Rocker Switch

(WN-2500 and WN-3500 only)



Wiring Accessory Kit



Hand Strap

(kit contents continued)

Yellow Wire



(6' long)



Blue Wire

Black Wire



(12' long)



Red Wire

Wireless Remote



CR2032 Batteries



remove (3) screws on back of Wireless Remote and install Batteries



“+”, on Batteries, to face installer

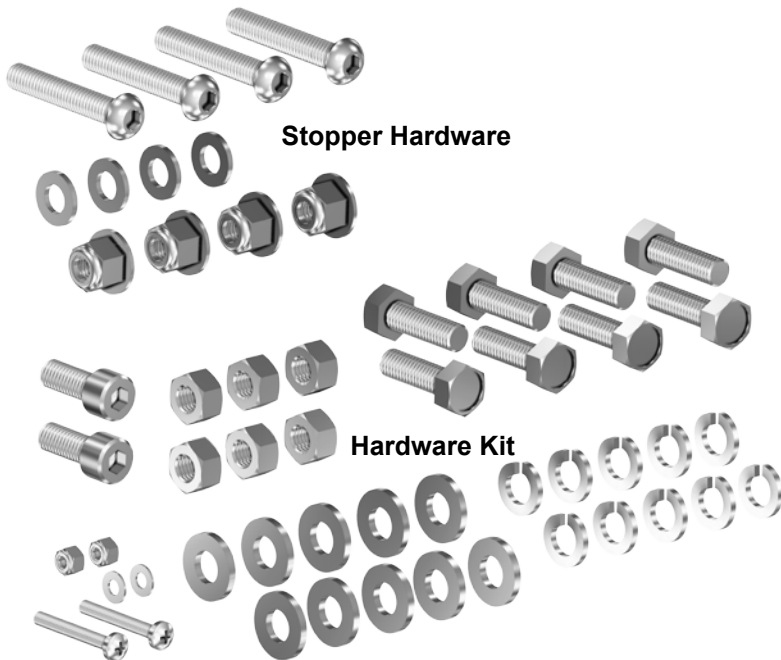

Stopper Hardware

Hardware Kit

RECOMMENDED WINCH ACCESSORIES (not included):

Gloves: Protect hands when handling Synthetic Rope.

Anchor Strap/Chain: 5,000 lbs. - 10,000 lbs. high tensile strength strap.

Blanket: Place on Synthetic Rope to absorb energy in event of a failure.

WN-2500 / WN-3500 / WN-4500 / WN-6000

INTRODUCTION:

Congratulations on your purchase of a high quality winch designed and built to strict specifications. Proper use and maintenance will ensure years of reliable, satisfying service.



WARNING: Read, study, and follow all instructions before operating winch.

Failure to heed these instructions may result in personal injury, death, and/or property damage.

A winch can develop tremendous pulling forces. If winch is used improperly, or in an unsafe manner, personal injury, death, and/or property damage can occur. Throughout this operating manual CAUTION, WARNING, and DANGER symbols are present. Pay particular attention to notes preceded by these symbols as they are written for your safety. User is responsible for safe operation of this device.



CAUTION

Indicates a potentially hazardous situation, which if not avoided, may result in minor or moderate injury. This symbol is also used to alert user against unsafe practices.



WARNING

Indicates a potentially hazardous situation, which if not avoided, may result in death or serious injury.

WIRING:

User may shorten wire length with components included in Wiring Accessory Kit.

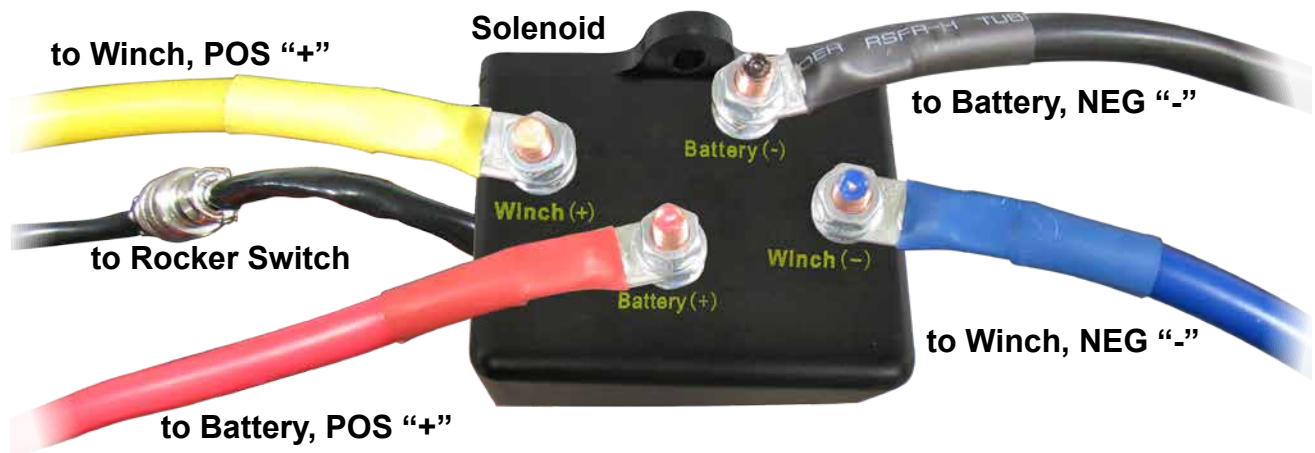

use (2) wrenches, one on each Nut, when tightening Terminals Posts; do not overtighten



torque all wiring connections to a maximum 35 in/lbs; use hand tools only

Winch (WN-4500 shown)

Winch NEG \"-\" →

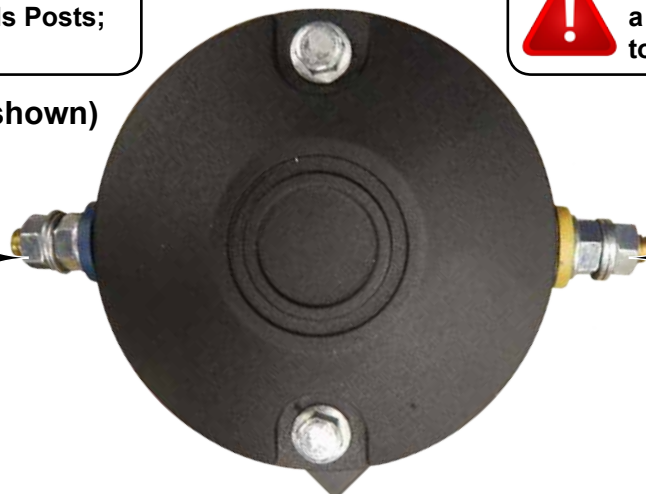

← Winch POS \"+\"

GETTING TO KNOW YOUR WINCH:

A winch is a powerful piece of machinery. For safe and confident operation, it is important to understand basic winch operations and specifications. See below for details on winch components and usage. Practice using winch before an actual situation occurs.

Winch has been engineered with several patented technologies.

Motor: Motor is powered by a 12 volt battery. Motor provides power to Mechanical Gear Mechanism which turns Winch Drum and winds Synthetic Rope.

Winch Drum: Cylinder on which Synthetic Rope is stored. Winch Drum feeds or winds Synthetic Rope depending on Winch switch direction.

Synthetic Rope: Designed specifically for Winches load capacity and is looped at end to accept clevis hook pin. Synthetic Rope feeds onto Winch Drum, through Fairlead, when in “under wind” position.

Fairlead: When operating Winch at an angle, Fairlead guides Synthetic Rope onto Winch Drum and minimizes damage/abrasion from winch mount or bumper.

Mechanical Gear System: Converts Motor power into extreme pulling forces.

Braking System: Braking action is automatically applied to Winch Drum when Motor is stopped and there is load on Synthetic Rope. A separate mechanical brake applies braking action.

Control System: Winch can be controlled by using Power Cord/Switch Assembly or through Remote Control.

Free Spooling Clutch: Allows user to manually disengage (“CLUTCH OUT”) Winch Drum from Mechanical Gear System; free spool. Engaging clutch (“CLUTCH IN”) locks Winch into Mechanical Gear System.

Solenoid: Power from vehicle battery flows through a weather-sealed switch before being directed to Motor.

Rocker Switch: Power switch leads have a dual switch for powering in or powering out Winch Drum. Rocker Switch allows user to stand clear of Synthetic Rope when Winch is under load.

Wireless Remote Control: Allows user to operate Winch from 50’ away. To turn on, push both buttons at once until LED lights up. To turn off, push both buttons at once until LED light goes out. ***Rocker Switch must be hooked up and key on power wire connected for remote to work.***

To turn ON:

- press and hold (2) buttons simultaneously until LED indicator turns on

To turn OFF:

- press and hold (2) buttons simultaneously until LED indicator shuts off
- remote will power off automatically after 2 minutes of inactivity



Mounting Plate: Plate that can mount to most flat surfaces such as trailers, step bumpers, truck beds, etc. Fairlead mounting holes included.

Pulley/Snatch Block (not included): Doubles pulling power of Winch or changes pulling direction without damaging Synthetic Rope. When pulling over 70% of rated line pull, it is recommended to use double line and snatch block.

SAFETY PRECAUTIONS:

Failure to heed these warnings and cautions may result in personal injury and/or property damage.

 **WARNING** - Do not exceed rated capacity. See “Performance Data”, page 6.

 **WARNING** - Do not use Winch to lift vertically or as a hoist.

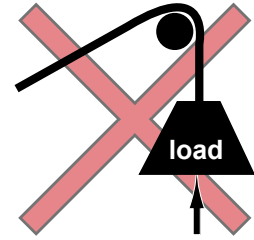

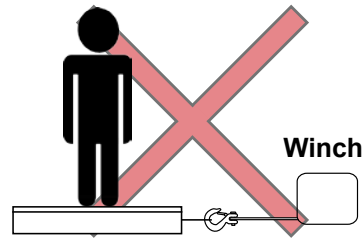

 **WARNING** - Do not use Winch to pull or move people in any way.



 **WARNING** - Never cut, weld, or modify any part of Winch or Synthetic Rope.

 **WARNING** - A minimum of (5) wraps of Synthetic Rope around Winch Drum is necessary for pulling and holding rated load.

 **WARNING** - Keep yourself and others a safe distance and to a side when Synthetic Rope is under tension.

 **WARNING** - Synthetic Rope may break before Motor stalls. For heavy loads at or near rated capacity, use a pulley block/snatch block to reduce load on Synthetic Rope.

 **WARNING** - When under load, never step over or go near Synthetic Rope.

 **WARNING** - Don't move vehicle to pull a load (towing) on Synthetic Rope. This can result in Synthetic Rope breakage.

 **WARNING** - Avoid “shock loads” by using control switch intermittently to take up slack in Synthetic Rope. “Shock loads” can exceed rated capacity for Synthetic Rope and Winch Drum.

 **WARNING** - Apply blocks to wheels of vehicle when on an incline.

SAFETY PRECAUTIONS (continued):

! **WARNING** - Never connect Synthetic Rope back onto itself.



! **CAUTION** - Use Hand Strap when handling Clevis Hook. Use gloves to protect hands when handling Synthetic Rope. Never let Synthetic Rope slide through bare hands.

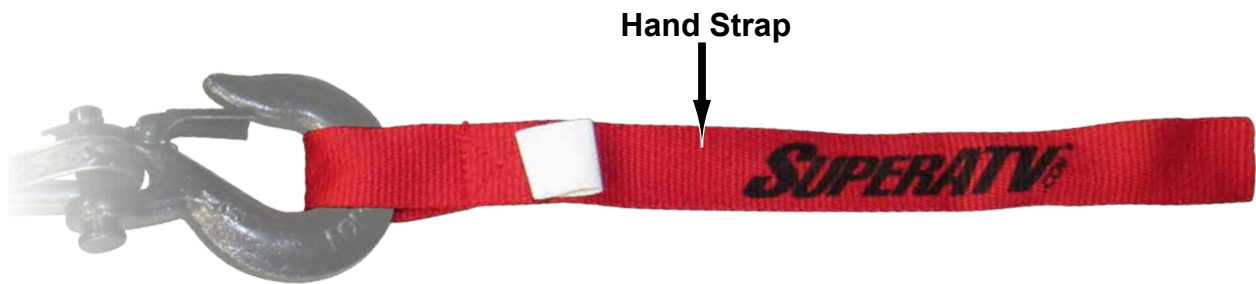

! **WARNING** - When re-spooling, ensure that Synthetic Rope spools in “under wind” position with Synthetic Rope entering Winch Drum from bottom, not top. To spool correctly, keep a slight load on Synthetic Rope while pushing remote button to draw in Synthetic Rope. Walk toward Winch while not allowing Synthetic Rope to slide through hands. Do not let hands get within 12” of Winch while re-spooling. Turn off Winch and repeat procedure until only a few feet of Synthetic Rope remain. Disconnect Remote Control and finish spooling by hand; rotate Winch Drum by hand with Clutch disengaged. Keep hands clear of Fairlead and Winch Drum while Winch is under power.

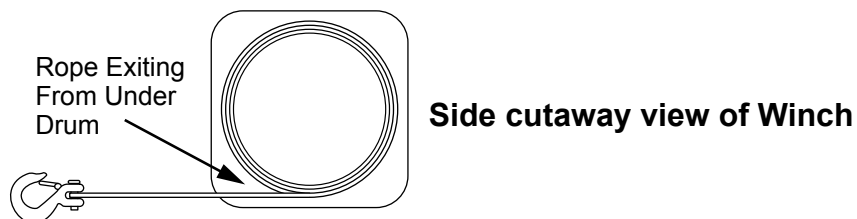

PERFORMANCE DATA:

Model WN-2500; 12V DC Motor, 1hp output

Line Pull (lbs - kgs)	Line Speed (Ft/min, M/min)	Motor (amps)	Pull by Layer (layer/lbs - kgs)
0	16.73 (5.10)	15	1/2500 (1134)
500 (227)	13.12 (4.00)	39	2/2045 (928)
1000 (454)	11.15 (3.40)	68	3/1731 (785)
1500 (680)	9.84 (3.00)	99	4/1500 (680)
2000 (907)	7.22 (2.20)	134	5/1324 (600)
2500 (1134)	4.92 (1.5)	158	6/1184 (537)

Model WN-3500; 12V DC Motor, 1.2hp output

Line Pull (lbs - kgs)	Line Speed (Ft/min, M/min)	Motor (amps)	Pull by Layer (layer/lbs - kgs)
0	17.52 (5.34)	21	1/3500 (1590)
500 (227)	15.55 (4.74)	41	2/2640 (1198)
1000 (454)	14.37 (4.38)	63	3/2320 (1052)
1500 (680)	12.99 (3.96)	83	4/2040 (925)
2000 (907)	10.43 (3.18)	100	
2500 (1134)	9.45 (2.88)	130	
3000 (1361)	7.87 (2.40)	156	
3500 (1588)	6.87 (2.1)	185	

Model WN-4500; 12V DC Motor, 1.3hp output

Line Pull (lbs - kgs)	Line Speed (Ft/min, M/min)	Motor (amps)	Pull by Layer (layer/lbs - kgs)
0	18.70 (5.70)	20	1/4500 (2045)
1000 (454)	16.07 (4.90)	61	2/3600 (1636)
2000 (907)	14.27 (4.35)	107	3/3130 (1423)
3000 (1361)	10.17 (3.10)	148	4/2745 (1248)
4000 (1814)	6.99 (2.13)	202	
4500 (2041)	6.10 (1.86)	267	

Model WN-6000; 12V DC Motor, 1.9hp output

Line Pull (lbs - kgs)	Line Speed (Ft/min, M/min)	Motor (amps)	Pull by Layer (layer/lbs - kgs)
0	13.45 (4.10)	13	1/6000 (2728)
1500 (681)	8.86 (2.70)	55	2/4615 (2097)
3000 (1361)	7.08 (2.16)	112	3/3845 (1748)
4500 (2045)	5.51 (1.68)	166	4/3205 (1457)
6000 (2727)	3.94 (1.2)	278	

GENERAL TIPS FOR SAFE OPERATION:

- Winch is at rated capacity when spooling first Synthetic Rope layer onto Winch Drum. Overloading can damage components. For loads over 70% of rated line pull, it is recommend to use a pulley block/snatch block to double rope line. When doubling line, number of layers on Winch Drum is reduced and load on Synthetic Rope is reduced by as much as 50%. Attach to frame or other load bearing component when doubling line back to vehicle.

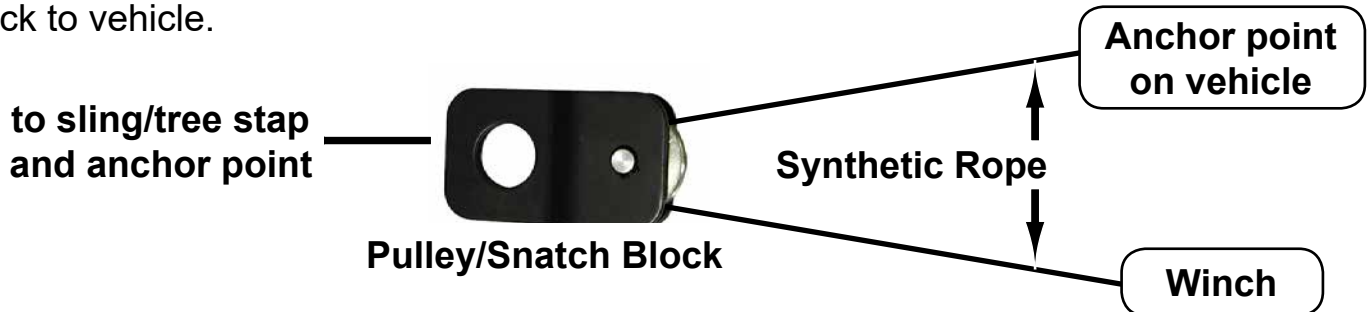

- To minimize battery drain and maximize power and speed of Winch, keep vehicle engine running during winching. Battery may be drained if winch is used for a considerable amount of time with engine off.
- Know all features before actual use. Become familiar with rigging techniques, sounds made under various loads, way Synthetic Rope spools onto Winch Drum, etc. by performing several test runs.
- Inspect all components, hardware, and electrical connections before each use. If Synthetic Rope is frayed or damaged, replace immediately. Use only manufacturers replacement rope. Replace or remove any component that appears to be damaged, worn, or operating abnormally.
- Never connect Synthetic Rope back onto itself. Always use a snatch block, sling, or chain of suitable strength.
- Pull only on parts of vehicle as specified by vehicle manufacturer.
- Use only attachments and/or adapters supplied by manufacturer.
- Test run Winch in (2) directions before winching.



CAUTION - If Motor stalls, stop winching immediately. Electric winches are designed for intermittent use. Do not use in constant duty applications. Keep duration of winching pulls as short as possible: Do not use for more than (1) minute when at or near rated load. If Motor becomes hot to touch, stop winching immediately. Allow Motor to cool before resuming.



CAUTION - Never disengage Free Spooling Clutch when a load is on Winch.

WINCH ASSEMBLY AND MOUNTING:

Winch is designed with a standard bolt pattern for its class. Different mounting kits are available that utilize this pattern.

When installing, ensure that Mounting Plate installs to a flat surface so Motor, Winch Drum, and Gear Housing are properly aligned. Proper alignment allows for even distribution of full rated loads.

Universal Mounting Plate is supplied. Machine specific Mounting Plates are available at www.SuperATV.com

1. Install supplied Fairlead to supplied Mounting Plate with supplied hardware.
2. Install Winch to Mounting Plate with supplied hardware:
 - Set Free Spooling Clutch to "OUT" and pull out a few inches of Synthetic Rope.
 - Feed Synthetic Rope through opening in front of Mounting Plate and through Fairlead.
3. Make electrical and component connections; *See SuperATV instructions.*

! **CAUTION** - Remove all jewelry and wear eye protection when making battery connections. Batteries contain flammable and explosive gases. Avoid leaning over battery.

4. Assemble Clevis Hook to Synthetic Rope.
 - Remove Pin from Clevis Hook and connect Clevis Hook to Synthetic Rope.
 - Reinstall Pin to Clevis Hook.
5. Install Stopper to Synthetic Rope.
6. Install Hand Strap to Clevis Hook.
7. Check Winch Drum for proper rotation:
 - Set Free Spooling Clutch to "OUT" and pull out some Synthetic Rope.
 - Set Free Spooling Clutch to "IN" and press "OUT" button on Rocker Switch. If properly installed, Winch Drum should be turning and *releasing* Synthetic Rope. If Winch Drum is turning and *collecting* more Synthetic Rope, reverse leads on Motor. Repeat and check rotation.

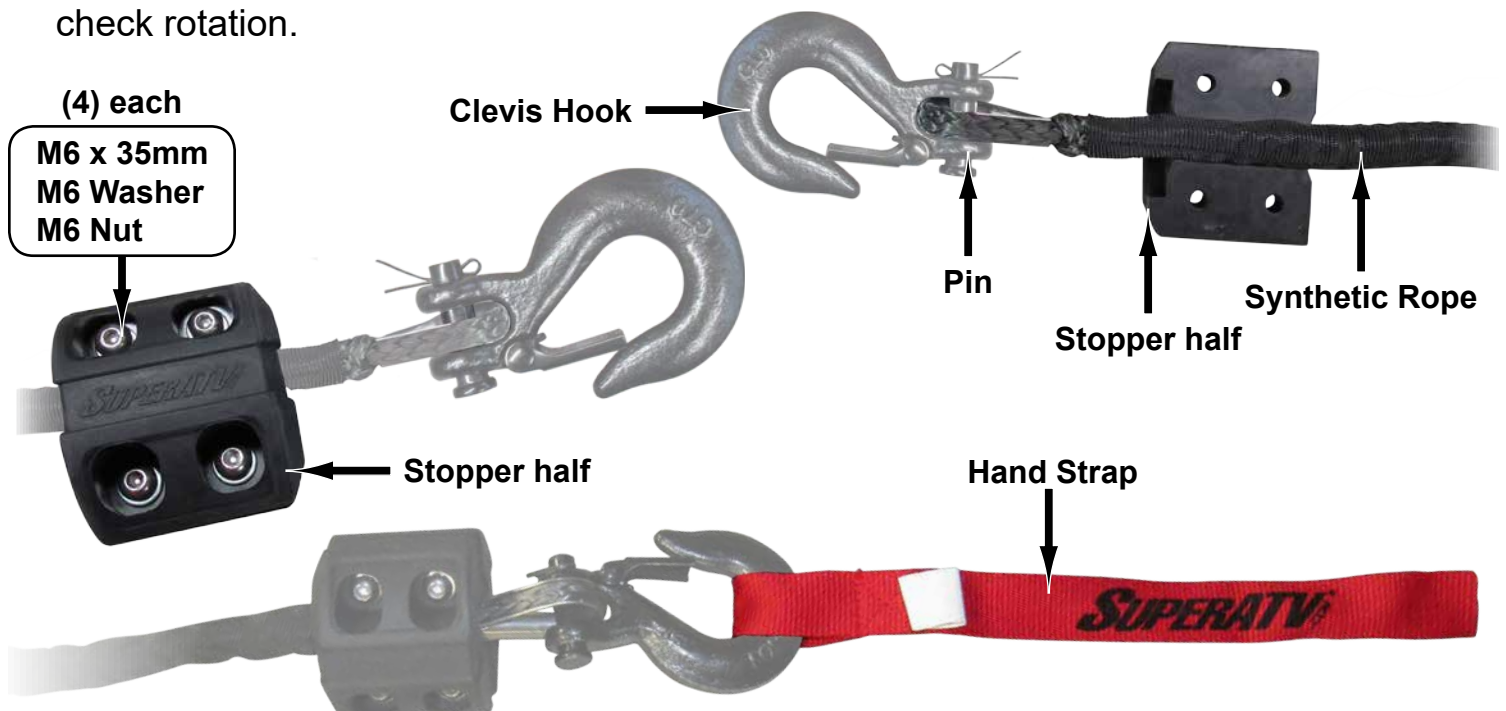

ROCKER MOUNTING (WN-2500 and WN-3500 only):

Rocker can be mounted to Handlebar as shown below.

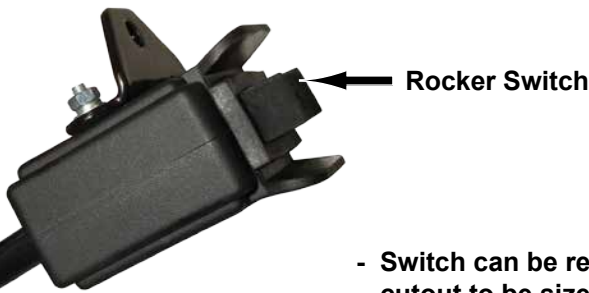
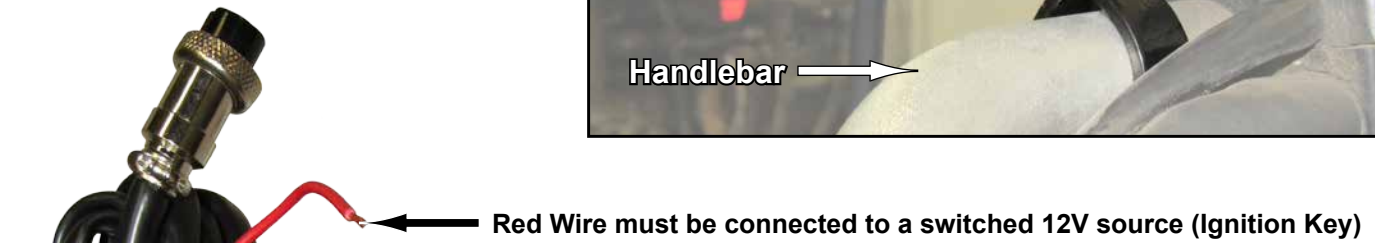
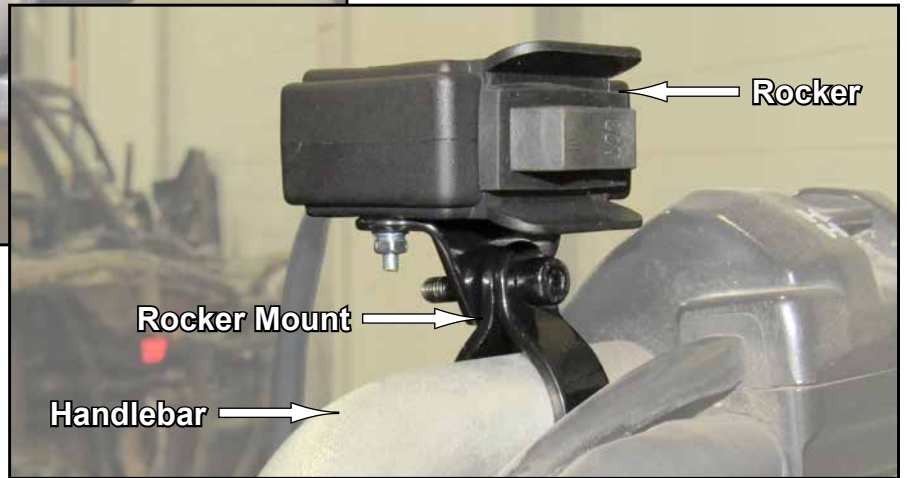
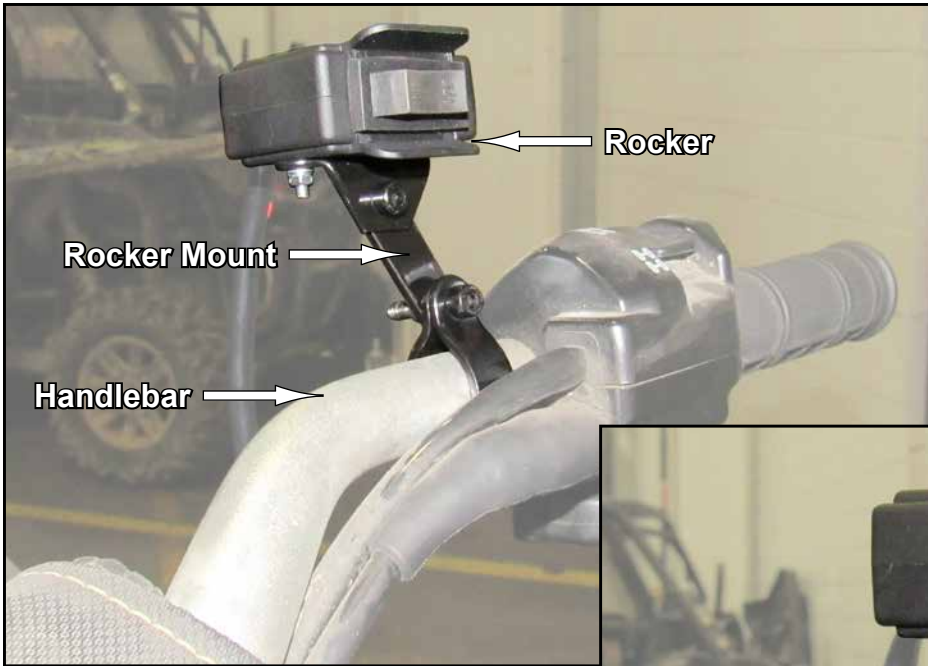

- Switch can be removed and installed into Dash
- cutout to be size shown
- insulate and waterproof any exposed wiring

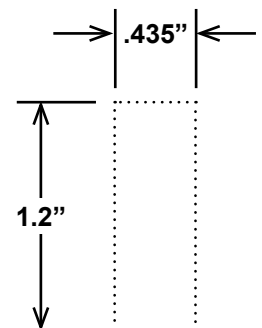
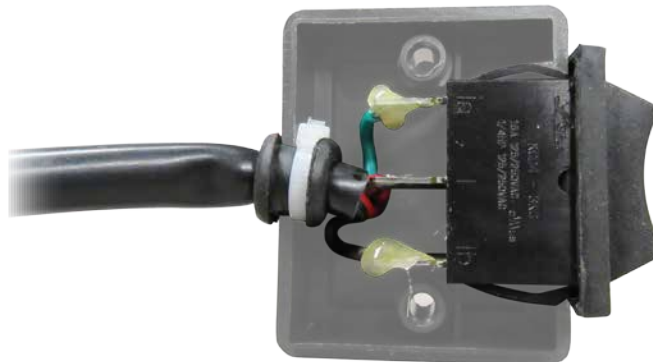

to connector on Solenoid (included with Winch) →

Red Wire must be connected
to a switched 12V source
(Ignition Key) →



Mounting Slot:

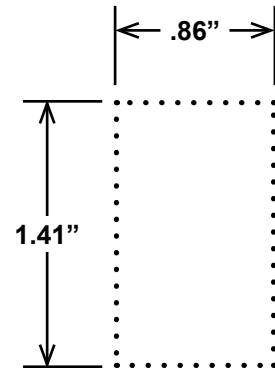

RIGGING TECHNIQUES:

Locate a suitable anchor such as a strong tree trunk or boulder. Always use a sling/tree strap as an anchor point.

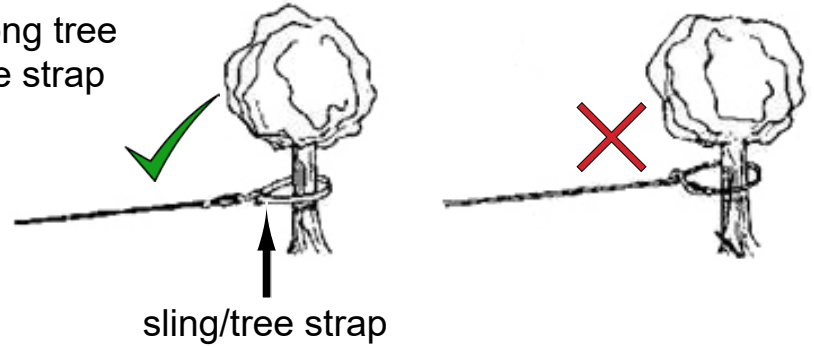

Do not winch from an acute angle. Synthetic Rope will pile up on one side of Winch Drum causing damage to Synthetic Rope and Winch.

Short pulls from an angle can be used to straighten vehicle. Long pulls must be done with Synthetic Rope at a 90° angle to winch/vehicle.

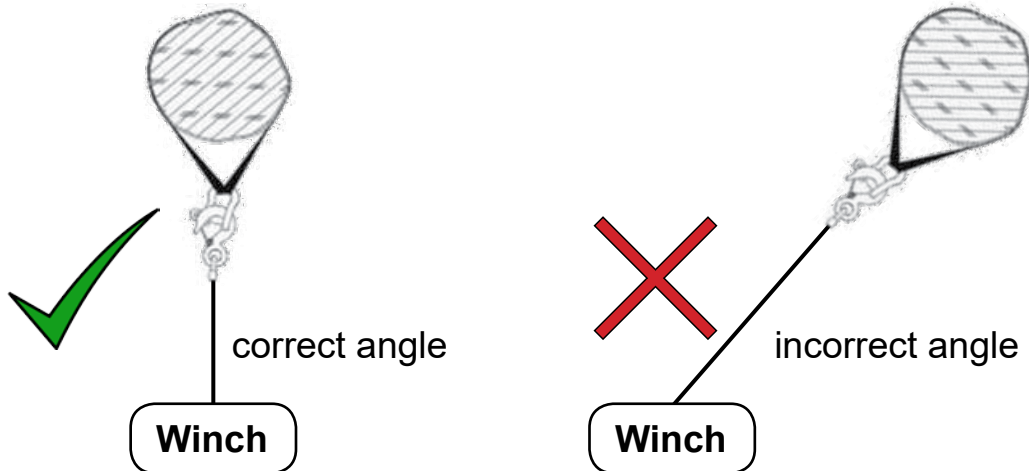

To absorb energy in event of Synthetic Rope failure, place a blanket or jacket over Synthetic Rope approximately 5ft - 6ft from Clevis Hook before pulling a heavy load. Open vehicle hood for more protection.

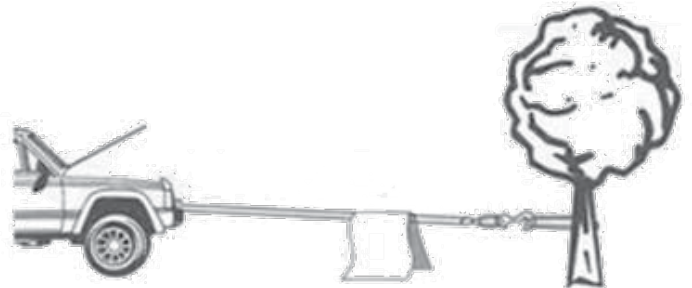

OPERATING WINCH:

1. Take time to assess situation and thoroughly plan pull.
2. Set Free Spooling Clutch to “CLUTCH OUT” position.
3. Pull Synthetic Rope and attach to vehicle to be winched. Wear gloves and use Hand Strap.



CAUTION - Always leave minimum of (5) turns of Synthetic Rope on Winch Drum. Review “Safety Warnings” section of manual before continuing.

4. Secure Clevis Hook to anchor point: Sling, chain or snatch block. Do not attach Clevis Hook back onto Synthetic Rope.
5. Set Free Spooling Clutch to “IN” position.
6. Start vehicle engine so that battery is being charged while winching.
7. Slowly winch in Synthetic Rope just enough to take up slack.
8. Inspect Synthetic Rope. Make sure there are minimum 5 wraps of Synthetic Rope around Winch Drum.
9. To absorb energy in event of Synthetic Rope failure, place a blanket or jacket over Synthetic Rope approximately 5ft - 6ft from Clevis Hook. Open vehicle hood for more protection.
10. Clear area. Make sure all spectators are away and that no one is directly in front, behind vehicle, or anchor point.
11. Vehicle to be winched should be placed in neutral and emergency brake released. Only release brake pedal when Synthetic Rope is under full tension.
12. While standing aside and clear of tow path, use Rocker Switch or Wireless Remote Control to control winching. If required, wait until Motor stops before reversing direction.
 - Be sure Synthetic Rope is winding evenly and tightly around Winch Drum.
 - Vehicle being winched can be slowly driven to add assistance to winching.
 - Avoid shock loads; keep Synthetic Rope under tension. This can damage components and vehicles.
13. Winch is meant for intermittent use. Under full load with a single line rig do not power “in” for more than (1) minute without letting Motor cool down for a few minutes before resuming winching.
14. Once vehicle is on stable ground, set brakes and place vehicle in park. Winching operation is complete.
15. Set Free Spooling Clutch to “OUT” to release tension on Synthetic Rope. Winch is not meant to hold loads for long periods of time.
16. Disconnect Synthetic Rope from vehicle or anchor.
18. Set Free Spooling Clutch to “IN” position and rewind Synthetic Rope. **Keep hands clear of Winch Drum and components.** Any material already on Winch Drum should be spooled tightly and neatly. Draw out and re-spool if necessary.
19. Secure Hook Strap and Clevis Hook.

TROUBLE SHOOTING:

SYMPTOM	POSSIBLE CAUSE	SUGGESTED ACTION
Motor does not turn on	Rocker Switch not connected properly.	Insert Rocker Switch completely into Controls Splitter Connector. Connect ignition power source.
	Loose battery cable connections.	Tighten nuts on all cable connections.
	Defective Rocker Switch.	Replace.
	Defective Motor.	Check for voltage at armature port with Rocker Switch pressed. If voltage is present, replace Motor.
	Water has entered Motor.	Allow water to drain and Winch to dry. Without a load, operate Winch in short cycles until completely dry.
	Solenoid sticking.	Tap on Solenoid with handle end of screwdriver.
Motor runs but Winch Drum does not turn.	Free Spooling Clutch not engaged.	Set Free Spooling Clutch to "IN" position. If problem persists, contact SuperATV.
Motor runs slowly or without normal power.	Insufficient current or voltage.	Battery is weak and may need charging. Always operate Winch with vehicle running. Corroded and/or loose battery cables should be cleaned and tightened.
Motor overheating.	Winch run time too long.	Periodically allow Winch to cool while operating.
Motor runs in one direction only.	Defective Rocker Switch/ Remote Control.	Repair or replace Rocker Switch/Remote Control.
	Loose battery cable connections.	Corroded and/or loose battery or Motor cable connections should be cleaned and tightened.
Motor runs continuously on its own.	Defective Solenoid, Wireless Receiver, or Remote Control.	Unplug ignition power. Remove negative battery cable from Solenoid.

SYNTHETIC ROPE MAINTENANCE:

- **Minimize abrasion:** Use movable Abrasion Sleeve whenever contact with rocks or other objects occurs. Slide Abrasion Sleeve up and down Synthetic Rope as required. Abrasion will reduce Synthetic Rope Life.
- **Keep clean:** Allowing dirt and debris to enter Synthetic Rope will lead to abrasion.
- **Avoid sharp bends:** A sharp bend will decrease Synthetic Ropes strength substantially under load and may cause damage or failure.



WARNING:

*If Synthetic Rope has become worn or is beginning to show signs of breaking, replace immediately. **Replace with identical part number.** Refer to SuperATV Synthetic Rope instruction when installing.*

MAINTENANCE:

- Check tightness of all mounting hardware and electrical connections periodically.
- Keep Winch clean. Remove all dirt and corrosion as required.
- Do not disassemble Mechanical Gear System. High temperature lithium grease has been applied at the factory. No user maintenance is required.

Winch Dimensions (all dimensions shown are in inches)

Model Number	A	B	C	D	E
WN-2500	12.20	3.08	5.91	4.75	4.6
WN-3500	12.76				
WN-4500	14.52	3.12	7.64		
WN-6000	14.57	2.85	7.4	4.86	4.41

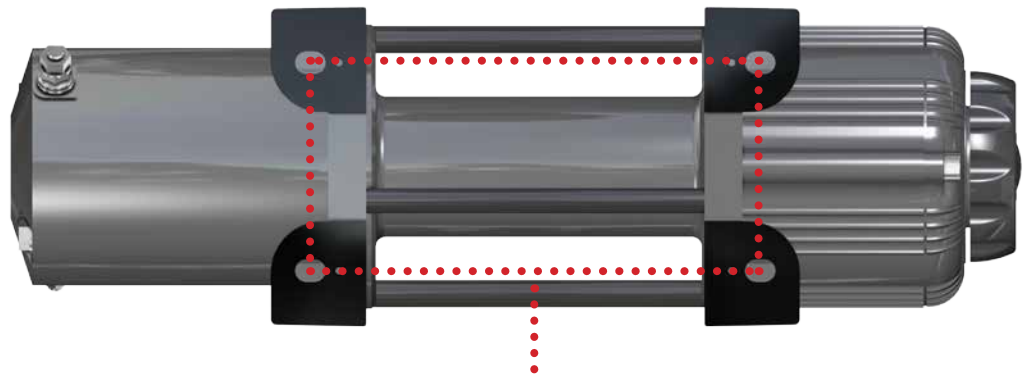
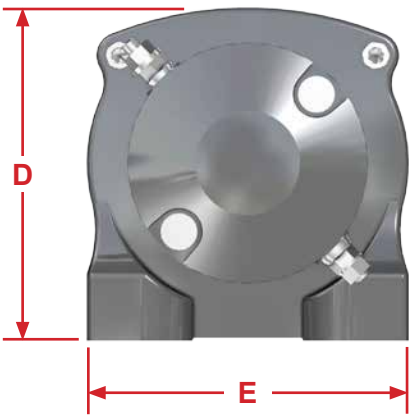
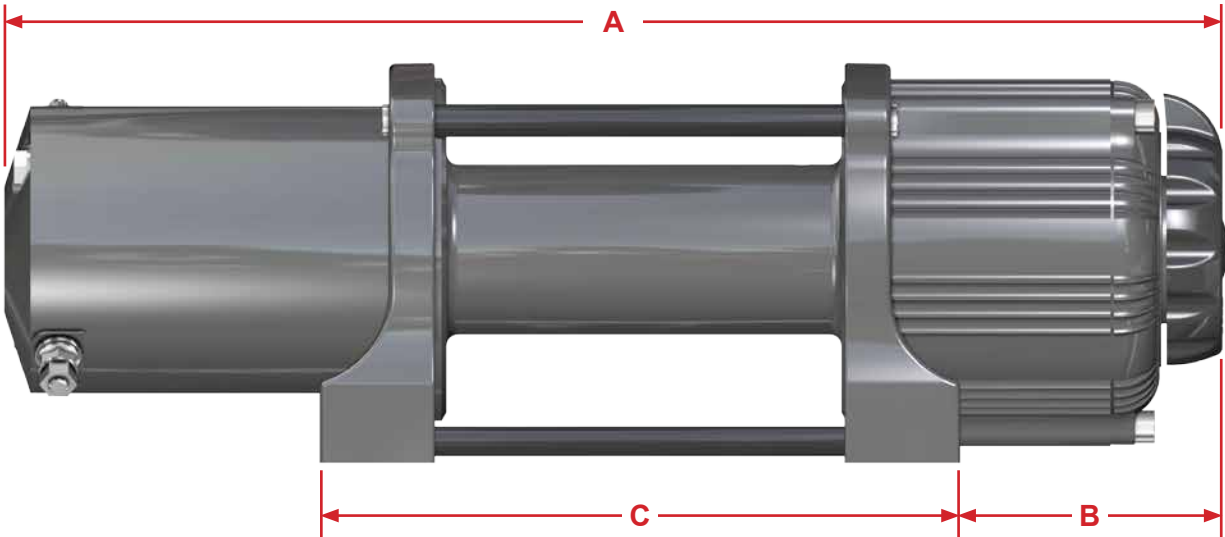

WN-2500 / WN-3500 Mounting Bolt Pattern = 4.75 x 3
WN-4500 Mounting Bolt Pattern = 6.5 x 3
WN-6000 Mounting Bolt Pattern = 6.61 x 3

- WN-2500:** Synthetic Rope (Diameter x Length): Ø3/16" x 50' (Ø4.8mm x 15.2m)
- WN-3500:** Synthetic Rope (Diameter x Length): Ø7/32" x 50' (Ø5.5mm x 15.2m)
- WN-4500:** Synthetic Rope (Diameter x Length): Ø1/4" x 50' (Ø6.3mm x 15.2m)
- WN-6000:** Synthetic Rope (Diameter x Length): Ø17/64" x 50' (Ø6.6mm x 15.2m)