

Item	Description
A	Winch Mount
B	Fairlead Grille
C	Fairlead Mount x 2

Winch not included; shown for illustration only.

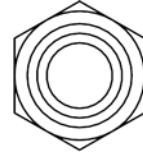

M10-1.50 Nylock Nut

Qty. (4) each

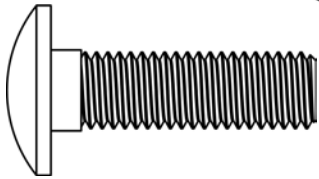

M10-1.50 x 35mm Lg. Carriage Bolt

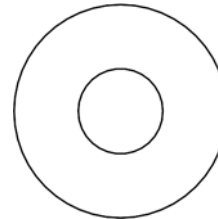

M10 Flat Washer

Read instructions and view illustrations before beginning.

Need help with your installation?

 sales@superatv.com
 www.superatv.com

 1-812-574-7777
  8:00am - 9:00pm EST M-Th
 8:00am - 7:00pm EST Friday
 9:00am - 2:00pm EST Saturday

Liability Statement
 SuperATV's® products are designed to best fit user's ATV/UTV under stock conditions. Adding, modifying, or fabricating any factory or aftermarket parts will void any warranty provided by SuperATV® and is not recommended. SuperATV's® products could interfere with other aftermarket accessories. If user has aftermarket products on machine, contact SuperATV® to verify that they will work together.

Although SuperATV® has thousands of satisfied customers, user should be aware that installing lift kits, long travel, or suspension kits, tires, etc. will change the ride of machine and may increase maintenance and part wear. Operating any off-road machine while, or after, consuming alcohol and/or drugs increases risk of bodily harm or death. No warranty or representation is made as to this product's ability to protect user from severe injury or death. SuperATV® urges operators and occupants to wear a helmet and appropriate riding gear at all times.

By purchasing and installing SuperATV® products, user agrees that should damages occur, SuperATV® will not be held responsible for loss of time, use, labor fees, replacement parts, or freight charges. SuperATV®, nor any 3rd party, will not be held responsible for any direct, indirect, incidental, special, or consequential damages that result from any product purchased from SuperATV®. The total liability of seller to user for all damages, losses, and causes of action, if any, shall not exceed the total purchase price paid for the product that gave rise to the claim.

SuperATV® will warranty only parts provided by SuperATV®. Any damage or problems with OEM housings, bearings, seals, or other manufacturers' products will not be covered by SuperATV®. SuperATV® parts and products are not warranted if item was not installed properly, misused, or modified.

Thank You
For Choosing
SUPERATV.COM[®]

Do not tighten hardware completely unless noted. Keep all components removed from machine.

- Remove Winch Cover and driver side Shock from machine.

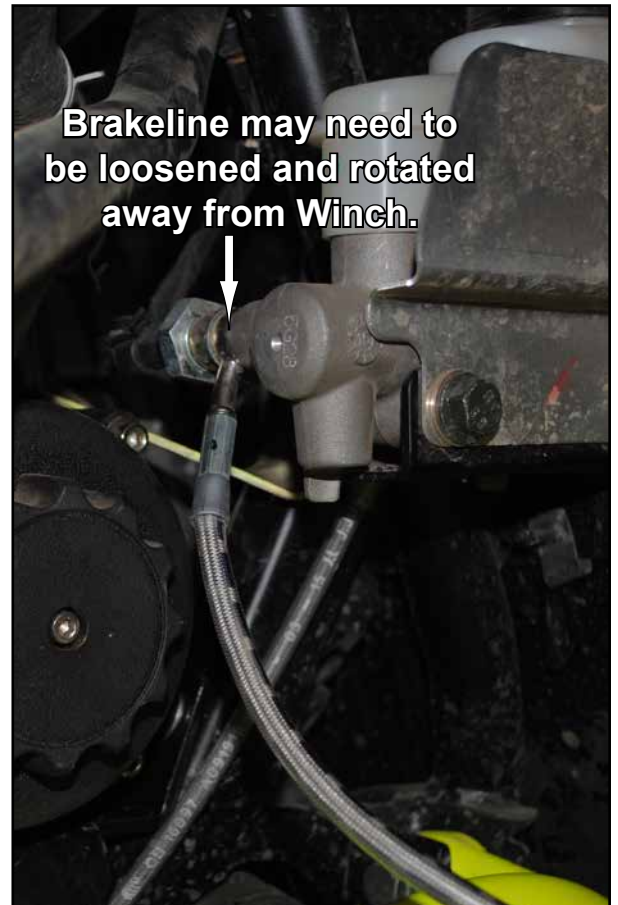
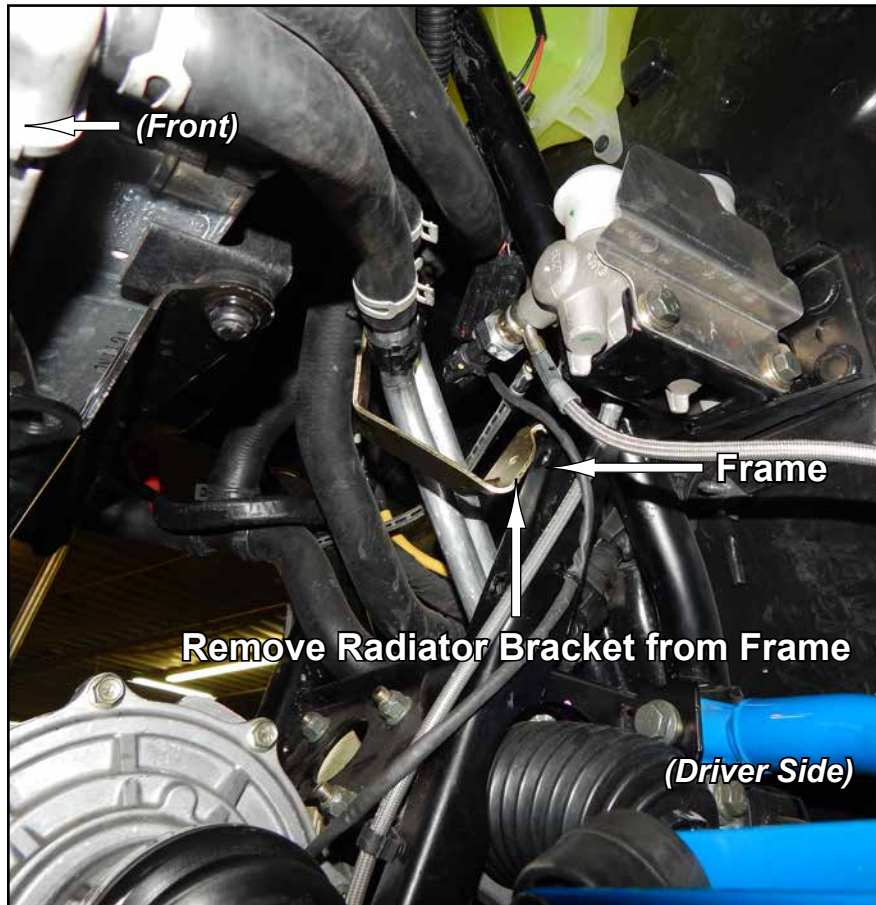

DO NOT TIGHTEN HARDWARE.

- Place Winch Mount (A) into machine and loosely install hardware shown into locations shown.

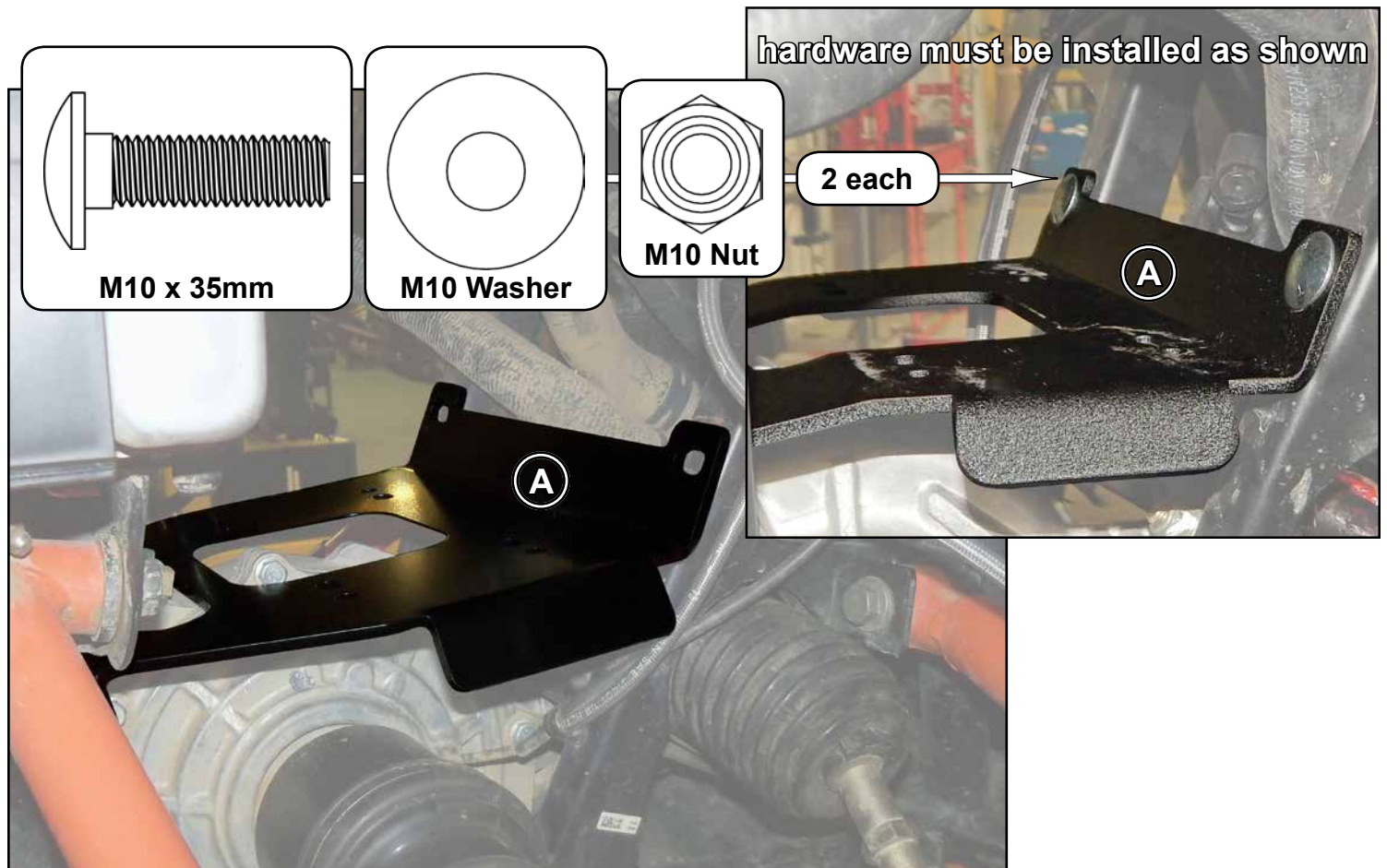
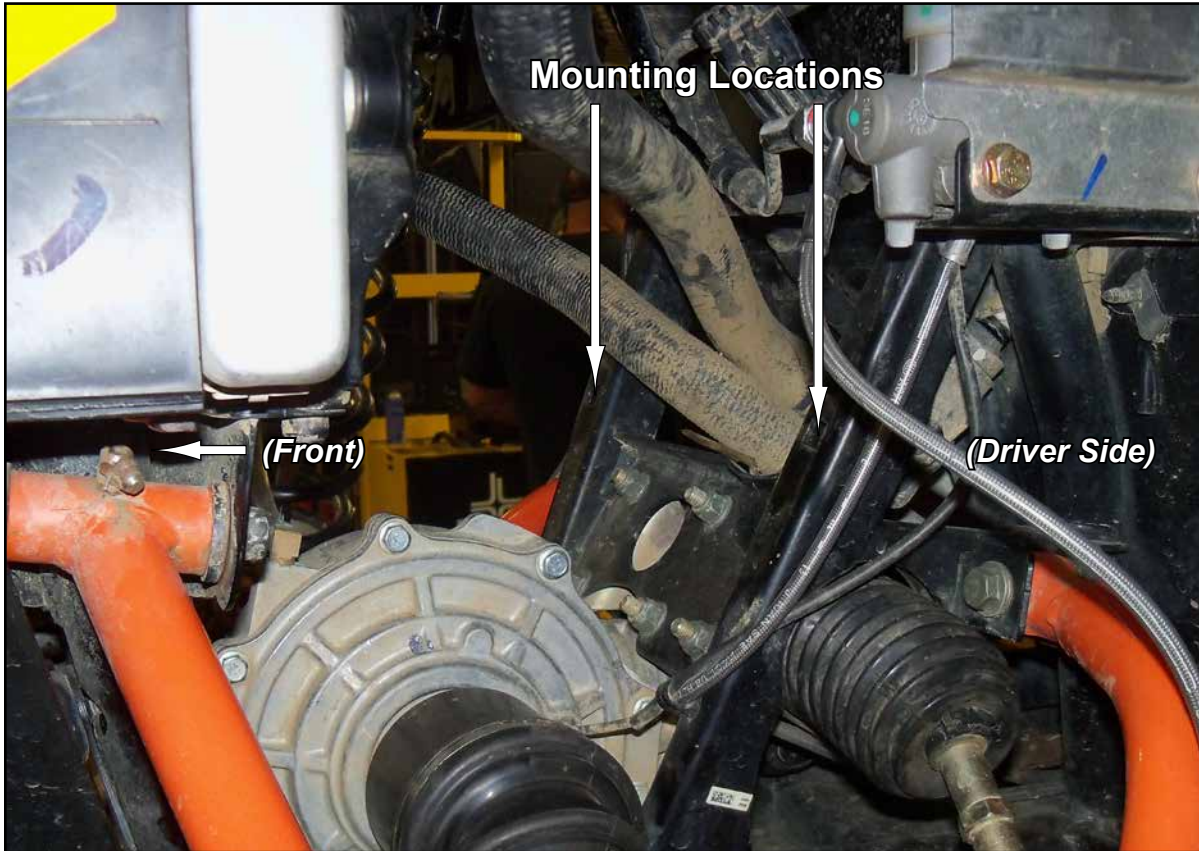

DO NOT TIGHTEN HARDWARE.

- Place Winch Mount (A) into machine and loosely install hardware shown into locations shown.

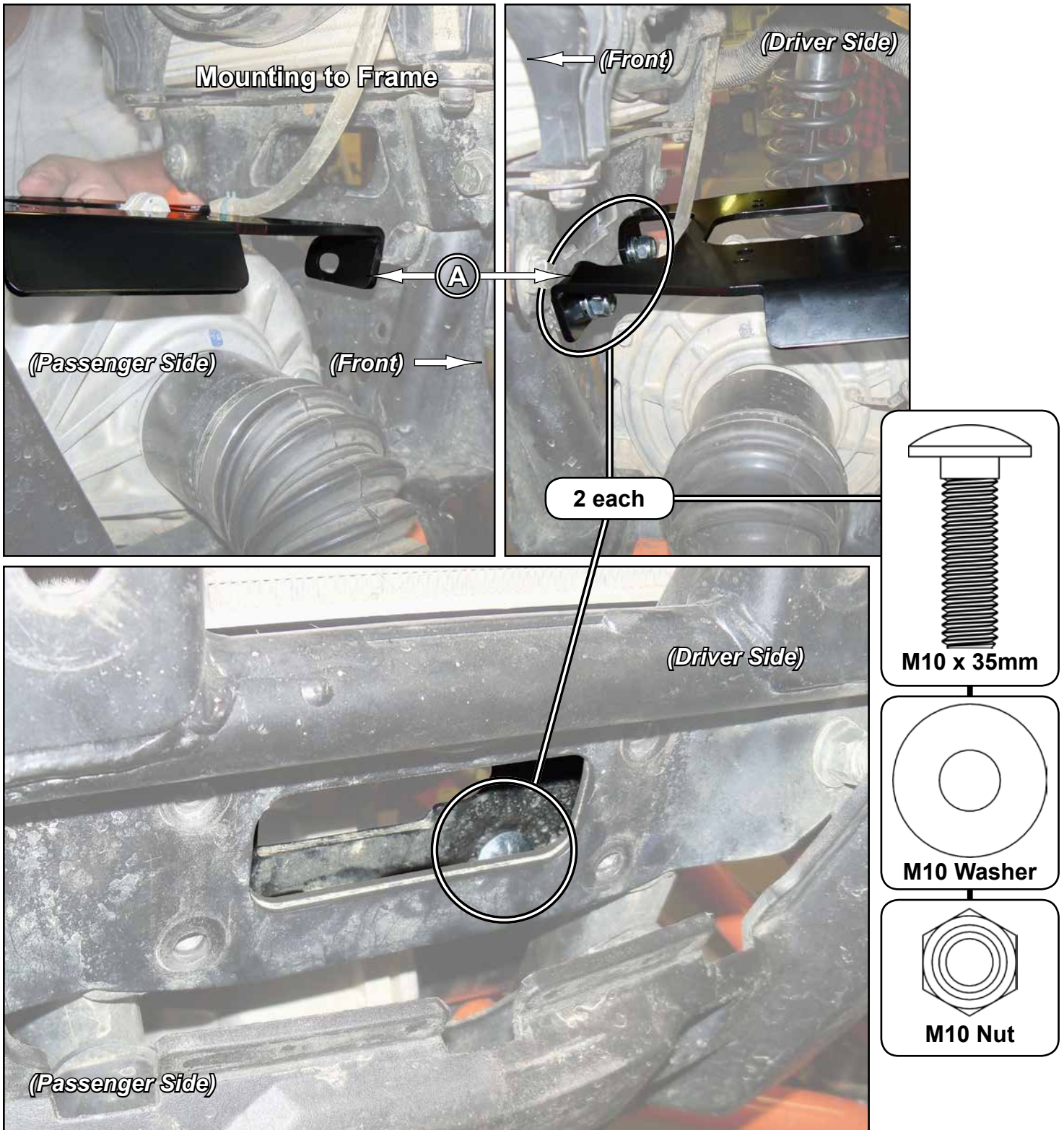

Tighten all hardware completely.

- Insert Winch, through driver side of machine, and secure to Winch Mount (A).
- Hardware included with Winch.

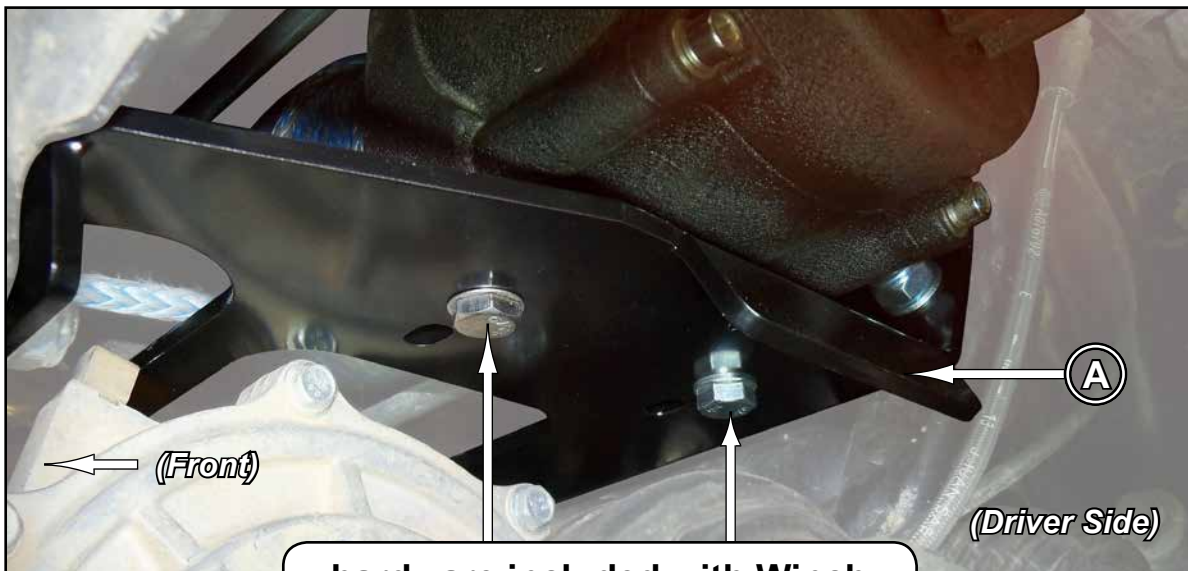
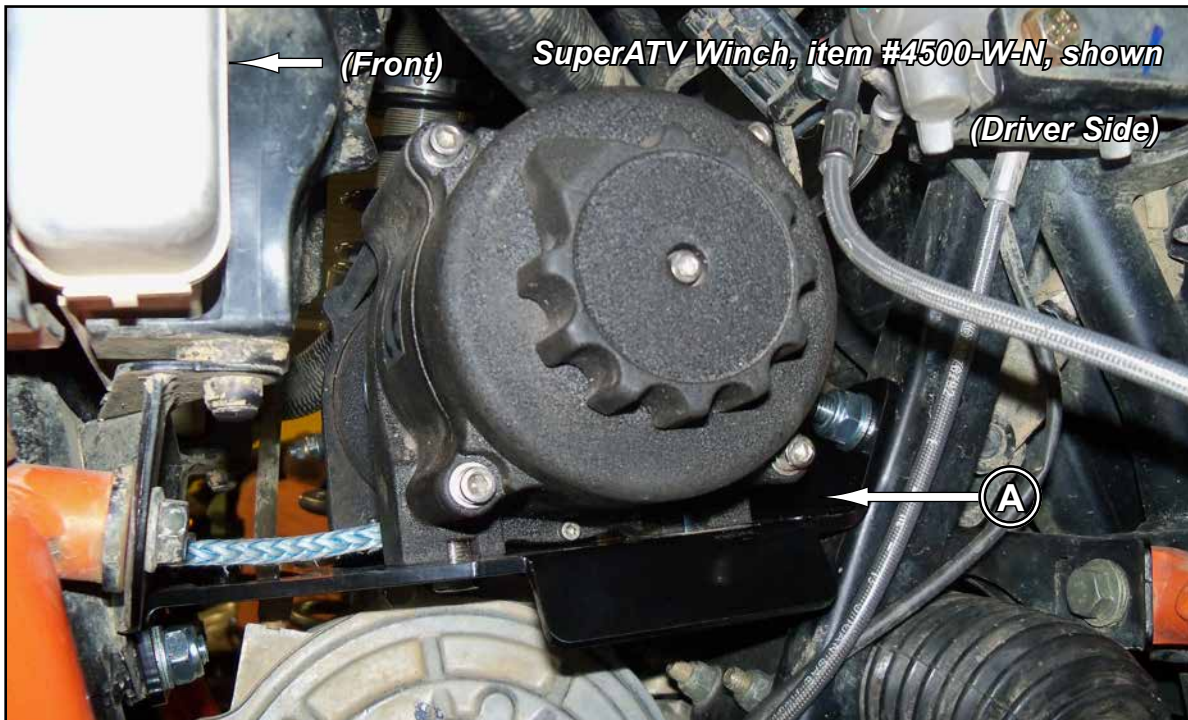

- Install Fairlead Mounts (C) to machine with stock hardware.
- *Note: SuperATV 3500 Lb. Winch will require flipping of Fairlead Mounts.*

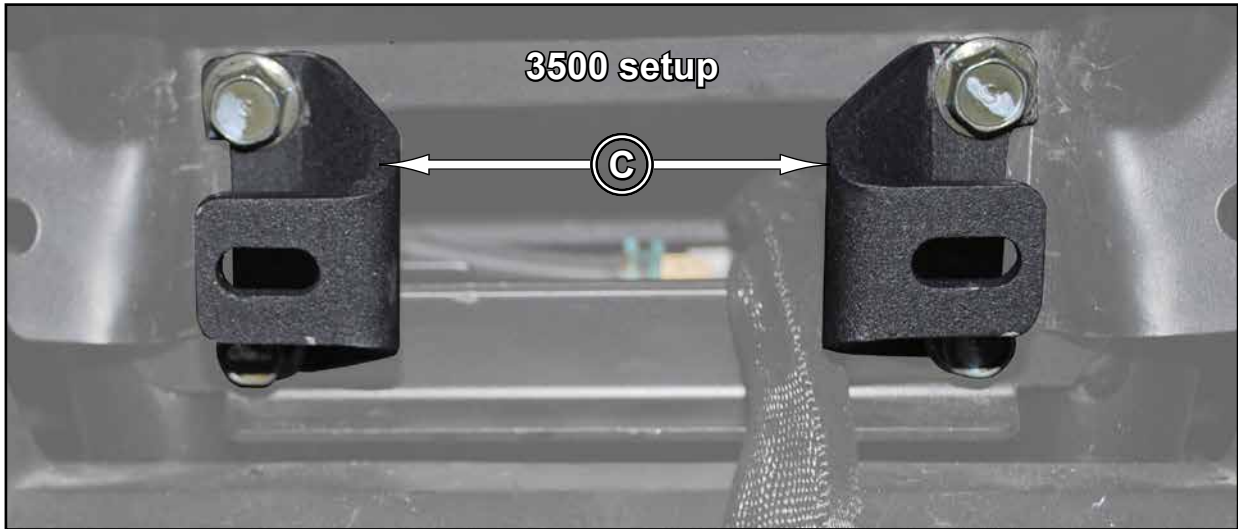
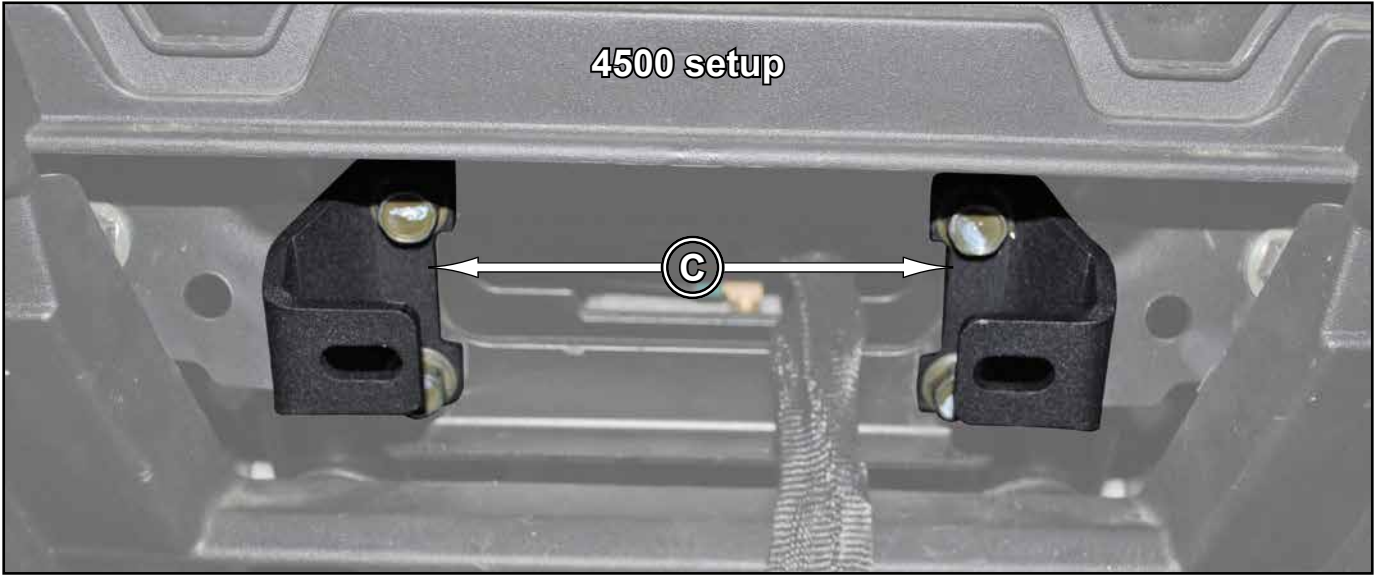

- Install Fairlead to Fairlead Mounts (C). Fairlead and hardware supplied with Winch.

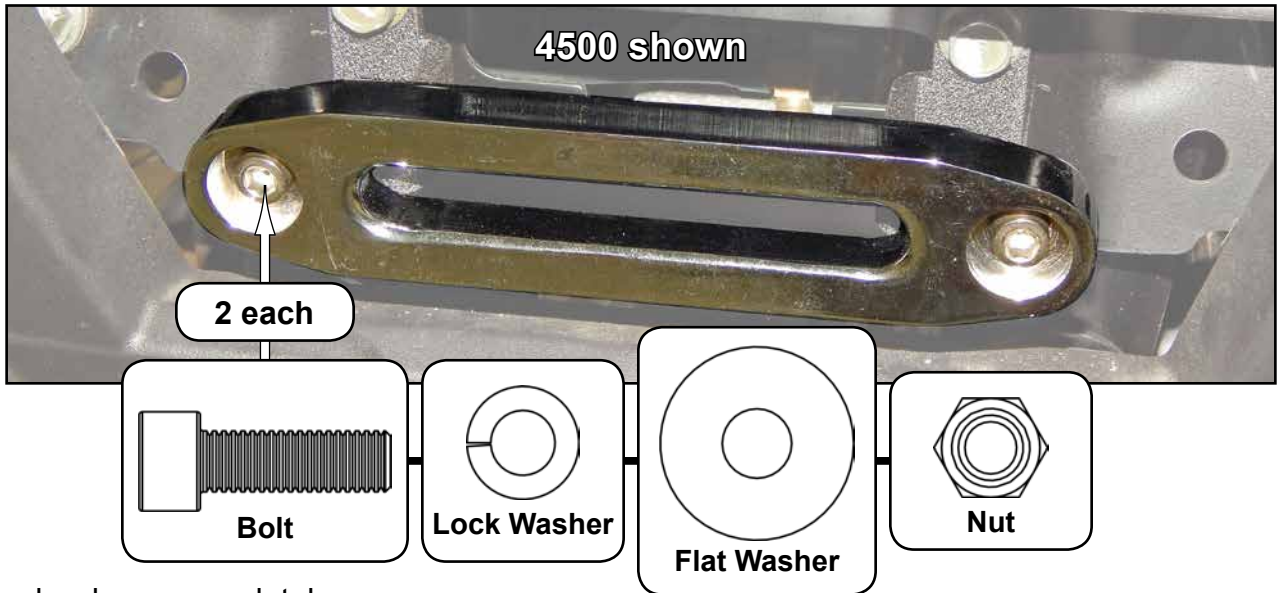

- Tighten hardware completely.

- Install Fairlead Grille (B) to stock locations as shown with stock hardware.



If installing on a 4 seat vehicle, and depending on winch model, extra lengths of wire may be required when wiring.